

CATALOGUE

Outillage pour le Forage



Toujours à votre service !

MCEP DISTRIBUTION vous propose avec ses partenaires une gamme d'outillage pour le forage qui inclut les équipements suivants:

- ↪ Outillage hors trou, du R22 au GT60 : taillants, allonges, manchons, emmanchements,
- ↪ **Outillage fond de trou, de 2" à 11" : taillants, tubes, marteaux,**
- ↪ Outillage Coprod : taillants COP76, COP89, COP102 et COP 127,
- ↪ Fleurets mono-blocs,
- ↪ Outillage conique,
- ↪ Outillage rotary.





SOMMAIRE

Outillage Hors Trou - R22	p. 4	Outillage Hors Trou - ST58	p. 43
Outillage Hors Trou - R23	p. 7	Outillage Hors Trou - ST68	p. 44
Outillage Hors Trou - R25	p. 8	Outillage Hors Trou - T38	p. 46
Outillage Hors Trou - R28	p. 15	Outillage Hors Trou - T45	p. 58
Outillage Hors Trou - R32	p. 20	Outillage Hors Trou - T51	p. 70
Outillage Hors Trou - GR34	p. 29	Outillage Hors Trou - GT60	p. 82
Outillage Hors Trou - R35	p. 33	Emmanchements	p. 89
Outillage Hors Trou - R38	p. 39	Autres Outils	p. 106

Button bit, Type D45

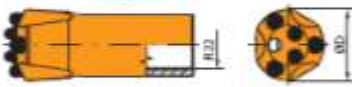

Button bit, Type D46

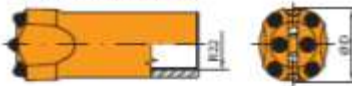

Button bit, Type D47

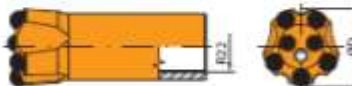

Chisel bit, Type D41

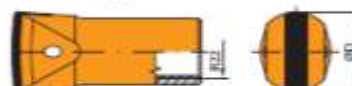

Cross bit, Type D42

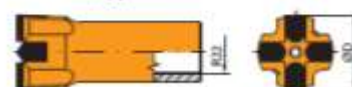

Diameter		Flushing holes (mm)		Buttons (mm)		Catalogue no.
mm	inch	Side	Front	Gauge	Front	
		No x Size	No x Size	No x Size	No x Size	
30	1 1/16	1 x 5	1 x 5	3 x 7	2 x 6	D45030R2205R
30	1 1/16	1 x 5	1 x 5	3 x 7	2 x 6	D45030R2205S
32	1 1/4	1 x 5	1 x 5	3 x 8	2 x 7	D45032R2205R
32	1 1/4	1 x 5	1 x 5	3 x 8	2 x 7	D45032R2205S
33	1 3/16	1 x 5	1 x 5	3 x 8	2 x 7	D45033R2205R
33	1 3/16	1 x 5	1 x 5	3 x 8	2 x 7	D45033R2205S
35	1 1/8	1 x 5	1 x 5	3 x 9	2 x 7	D45035R2205R
35	1 1/8	1 x 5	1 x 5	3 x 9	2 x 7	D45035R2205S
32	1 1/4	-	2 x 5	4 x 7	2 x 6	D46032R2205R
32	1 1/4	-	2 x 5	4 x 7	2 x 6	D46032R2205S
33	1 3/16	-	2 x 5	4 x 7	2 x 7	D46033R2205R
33	1 3/16	-	2 x 5	4 x 7	2 x 7	D46033R2205S
35	1 1/8	-	2 x 5	4 x 8	2 x 7	D46035R2205R
35	1 1/8	-	2 x 5	4 x 8	2 x 7	D46035R2205S
37	1 3/8	-	2 x 5	4 x 8	2 x 7	D46037R2205R
37	1 3/8	-	2 x 5	4 x 8	2 x 7	D46037R2205S
38	1 1/2	-	2 x 5	4 x 9	2 x 7	D46038R2205R
38	1 1/2	-	2 x 5	4 x 9	2 x 7	D46038R2205S
41	1 5/8	-	2 x 5	4 x 9	2 x 8	D46041R2205R
41	1 5/8	-	2 x 5	4 x 9	2 x 8	D46041R2205S
32	1 1/4	1 x 5	1 x 5	5 x 7	2 x 6	D47032R2205R
32	1 1/4	1 x 5	1 x 5	5 x 7	2 x 6	D47032R2205S
33	1 3/16	1 x 5	1 x 5	5 x 7	2 x 7	D47033R2205R
33	1 3/16	1 x 5	1 x 5	5 x 7	2 x 7	D47033R2205S
35	1 1/8	1 x 6	1 x 5	5 x 8	2 x 7	D47035R2205R
35	1 1/8	1 x 6	1 x 5	5 x 8	2 x 7	D47035R2205S
37	1 3/8	1 x 6	1 x 5	5 x 8	2 x 7	D47037R2205R
37	1 3/8	1 x 6	1 x 5	5 x 8	2 x 7	D47037R2205S
38	1 1/2	1 x 6	1 x 5	5 x 9	2 x 7	D47038R2205R
38	1 1/2	1 x 6	1 x 5	5 x 9	2 x 7	D47038R2205S
41	1 5/8	1 x 6	1 x 5	5 x 9	2 x 8	D47041R2205R
41	1 5/8	1 x 6	1 x 5	5 x 9	2 x 8	D47041R2205S

Diameter		Flushing holes (mm)		Catalogue no.
mm	inch	Side	Front	
		No x Size	No x Size	
30	1 1/16	2 x 5	-	D41030R2202
32	1 1/4	2 x 5	-	D41032R2202
35	1 1/8	2 x 5	-	D41035R2202
38	1 1/2	2 x 5	-	D41038R2202
41	1 5/8	2 x 5	-	D41041R2202
43	1 7/16	2 x 6	-	D41043R2202
45	1 3/8	2 x 6	-	D41045R2202
30	1 1/16	2 x 5	1 x 4,5	D42030R2202
32	1 1/4	2 x 5	1 x 4,5	D42032R2202
35	1 1/8	2 x 5	1 x 4,5	D42035R2202
38	1 1/2	2 x 5	1 x 4,5	D42038R2202
41	1 5/8	2 x 5	1 x 4,5	D42041R2202
45	1 3/8	2 x 5	1 x 4,5	D42045R2202

Shank rod, Hex 22 - R22

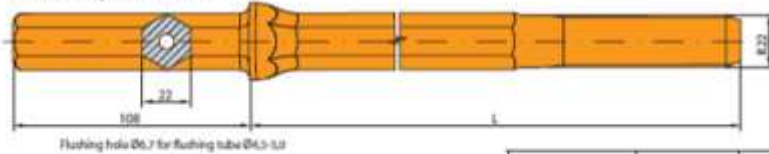

Hex		Thread	Dimensions			Catalogue no.
mm	inch		Length			
mm	inch		mm	ft	inch	
22	¾	R22	610	2	-	25117060
22	¾	R22	760	2	6	25117076
22	¾	R22	1600	5	3	25117160
22	¾	R22	1830	6	-	25117183
22	¾	R22	2435	8	-	25117243
22	¾	R22	3050	10	-	25117305
22	¾	R22	3660	12	-	25117366

Drifter rod, R22 - Hex 22 - R22

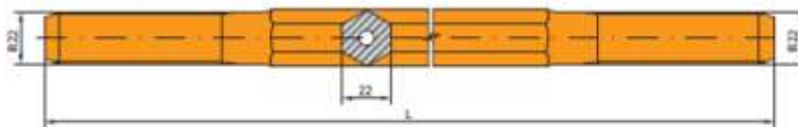

Hex		Threads	Dimensions			Catalogue no.
mm	inch		Length			
mm	inch		mm	ft	inch	
22	¾	R22/R22	610	2	-	24717061
22	¾	R22/R22	760	2	6	24717076
22	¾	R22/R22	1600	5	3	24717160
22	¾	R22/R22	1830	6	-	24717183
22	¾	R22/R22	2435	8	-	24717243
22	¾	R22/R22	3050	10	-	24717305
22	¾	R22/R22	3660	12	-	24717366

Drifter rod, R32 - Hex 25 - R22

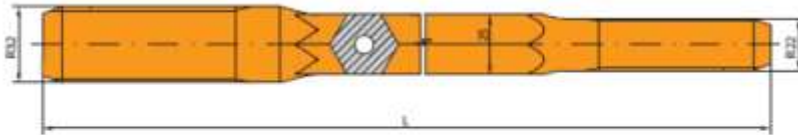

Hex		Threads	Dimensions			Catalogue no.
mm	inch		Length			
			mm	ft	inch	
25	1	R32/R22	610	2	-	20417061
25	1	R32/R22	760	2	6	20417076
25	1	R32/R22	1600	5	3	20417160
25	1	R32/R22	1830	6	-	20417183
25	1	R32/R22	2435	8	-	20417243
25	1	R32/R22	3050	10	-	20417305
25	1	R32/R22	3660	12	-	20417366

Coupling sleeve R22

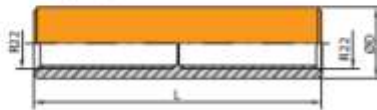

Diameter		Threads	Length		Catalogue no.
mm	inch		mm	inch	
32	1 ¼	R22/R22	140	5 ½	3971700

Button bit, Type D47

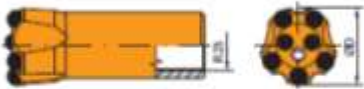

Diameter		Flushing holes (mm)		Buttons (mm)		Catalogue no.
		Side	Front	Gauge	Front	
mm	inch	No x Size	No x Size	No x Size	No x Size	
33	1 1/4	1 x 6	1 x 4	5 x 7	2 x 7	D47033R2305R
33	1 1/4	1 x 6	1 x 4	5 x 7	2 x 7	D47033R2305S
35	1 1/8	1 x 6	1 x 6	5 x 8	2 x 7	D47035R2305R
35	1 1/8	1 x 6	1 x 6	5 x 8	2 x 7	D47035R2305S
38	1 1/2	1 x 6	1 x 6	5 x 8	2 x 7	D47038R2305R
38	1 1/2	1 x 6	1 x 6	5 x 8	2 x 7	D47038R2305S
41	1 3/8	1 x 6	1 x 6	5 x 9	2 x 8	D47041R2305R
41	1 3/8	1 x 6	1 x 6	5 x 9	2 x 8	D47041R2305S

MF-rod, R23 - Hex 22 - R23

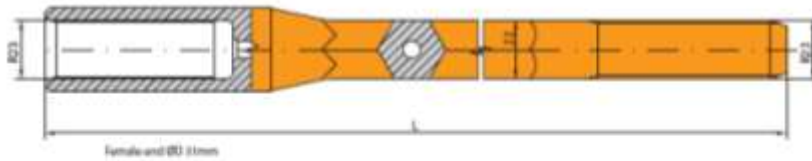

Hex		Threads	Dimensions			Catalogue no.
			Length			
mm	inch		mm	ft	inch	
22	11/16	R23/R23	915	3	-	11H22R23R23091
22	11/16	R23/R23	1220	4	-	11H22R23R23122
22	11/16	R23/R23	1525	5	-	11H22R23R23152
22	11/16	R23/R23	1830	6	-	11H22R23R23183
22	11/16	R23/R23	2435	8	-	11H22R23R23243
22	11/16	R23/R23	3050	10	-	11H22R23R23305
22	11/16	R23/R23	3660	12	-	11H22R23R23366
22	11/16	R23/R23	4305	13	1 1/8	11H22R23R23430

Button bit, Type D46

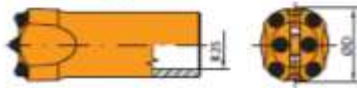

Button bit, Type D47

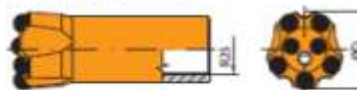

Diameter		Flushing holes (mm)		Buttons (mm)		Catalogue no.
		Side	Front	Gauge	Front	
mm	inch	No x Size	No x Size	No x Size	No x Size	
33	1 3/4	-	2 x 5	4 x 7	2 x 7	D46033R2505R
33	1 3/4	-	2 x 5	4 x 7	2 x 7	D46033R2505S
35	1 3/8	-	2 x 5	4 x 8	2 x 7	D46035R2505R
35	1 3/8	-	2 x 5	4 x 8	2 x 7	D46035R2505S
37	1 5/8	-	2 x 5	4 x 8	2 x 7	D46037R2505R
37	1 5/8	-	2 x 5	4 x 8	2 x 7	D46037R2505S
38	1 1/2	-	2 x 5	4 x 9	2 x 7	D46038R2505R
38	1 1/2	-	2 x 5	4 x 9	2 x 7	D46038R2505S
41	1 5/8	-	2 x 6	4 x 9	2 x 8	D46041R2505R
41	1 5/8	-	2 x 6	4 x 9	2 x 8	D46041R2505S
43	1 7/8	-	2 x 6	4 x 10	2 x 8	D46043R2505R
43	1 7/8	-	2 x 6	4 x 10	2 x 8	D46043R2505S
45	1 3/4	-	2 x 6	4 x 10	2 x 9	D46045R2505R
45	1 3/4	-	2 x 6	4 x 10	2 x 9	D46045R2505S
33	1 3/4	1 x 5	1 x 5	5 x 7	2 x 7	D47033R2505R
33	1 3/4	1 x 5	1 x 5	5 x 7	2 x 7	D47033R2505S
35	1 3/8	1 x 6	1 x 5	5 x 8	2 x 7	D47035R2505R
35	1 3/8	1 x 6	1 x 5	5 x 8	2 x 7	D47035R2505S
37	1 5/8	1 x 6	1 x 5	5 x 8	2 x 7	D47037R2505R
37	1 5/8	1 x 6	1 x 5	5 x 8	2 x 7	D47037R2505S
38	1 1/2	1 x 6	1 x 5	5 x 9	2 x 7	D47038R2505R
38	1 1/2	1 x 6	1 x 5	5 x 9	2 x 7	D47038R2505S
41	1 5/8	1 x 6	1 x 5	5 x 9	2 x 8	D47041R2505R
41	1 5/8	1 x 6	1 x 5	5 x 9	2 x 8	D47041R2505S
43	1 7/8	1 x 6	1 x 5	5 x 10	2 x 8	D47043R2505R
43	1 7/8	1 x 6	1 x 5	5 x 10	2 x 8	D47043R2505S
45	1 3/4	1 x 6	1 x 5	5 x 10	2 x 9	D47045R2505R
45	1 3/4	1 x 6	1 x 5	5 x 10	2 x 9	D47045R2505S

Button bit, Type D49

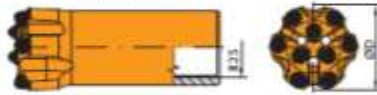

Reaming bit, Type D51

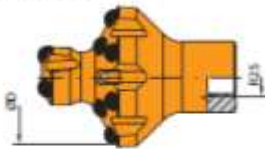

Reaming equipment, Type D50



Diameter		Flushing holes (mm)		Buttons (mm)		Catalogue no.
mm	inch	Side	Front	Gauge	Front	
		No x Size	No x Size	No x Size	No x Size	
35	1 3/8	-	3 x 5	6 x 7	3 x 7	D49035R2505R
35	1 3/8	-	3 x 5	6 x 7	3 x 7	D49035R2505S
37	1 7/16	1 x 5	3 x 5	6 x 7	3 x 7	D49037R2505R
37	1 7/16	1 x 5	3 x 5	6 x 7	3 x 7	D49037R2505S
38	1 1/2	1 x 5	3 x 5	6 x 8	3 x 7	D49038R2505R
38	1 1/2	1 x 5	3 x 5	6 x 8	3 x 7	D49038R2505S
41	1 5/8	1 x 5	3 x 5	6 x 8	3 x 7	D49041R2505R
41	1 5/8	1 x 5	3 x 5	6 x 8	3 x 7	D49041R2505S
43	1 7/8	1 x 5	3 x 5	6 x 9	3 x 8	D49043R2505R
43	1 7/8	1 x 5	3 x 5	6 x 9	3 x 8	D49043R2505S
45	1 7/8	1 x 5	3 x 5	6 x 10	3 x 8	D49045R2505R
45	1 7/8	1 x 5	3 x 5	6 x 10	3 x 8	D49045R2505S
48	1 7/8	1 x 5	3 x 5	6 x 10	3 x 9	D49048R2505R
48	1 7/8	1 x 5	3 x 5	6 x 10	3 x 9	D49048R2505S
51	2	1 x 5	3 x 5	6 x 10	3 x 9	D49051R2505R
51	2	1 x 5	3 x 5	6 x 10	3 x 9	D49051R2505S
64	2 1/2	-	4 x 5	8 x 9	7 x 8	D51064R2505R
64	2 1/2	-	4 x 5	8 x 9	7 x 8	D51064R2505S
76	3	-	4 x 5	8 x 10	7 x 9	D51076R2505R
76	3	-	4 x 5	8 x 10	7 x 9	D51076R2505S
89	3 1/2	-	4 x 5	8 x 12	7 x 10	D51089R2505R
89	3 1/2	-	4 x 5	8 x 12	7 x 10	D51089R2505S
102	4	-	4 x 5	8 x 13	7 x 13	D51102R2505R
102	4	-	4 x 5	8 x 13	7 x 13	D51102R2505S
64	2 1/2	-	2 x 5	8 x 9	4 x 8	D50064R25R2205R
64	2 1/2	-	2 x 5	8 x 9	4 x 8	D50064R25R2205S
76	3	-	2 x 5	8 x 10	4 x 10	D50076R25R2205R
76	3	-	2 x 5	8 x 10	4 x 10	D50076R25R2205S
89	3 1/2	-	2 x 5	8 x 10	6 x 10	D50089R25R2205R
89	3 1/2	-	2 x 5	8 x 10	6 x 10	D50089R25R2205S
105	4 1/8	-	2 x 5	8 x 12	4 x 12	D50105R25R2205R
105	4 1/8	-	2 x 5	8 x 12	4 x 12	D50105R25R2205S

Chisel bit, Type D41

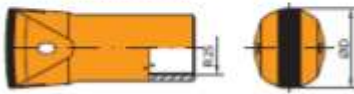

Cross bit, Type D42

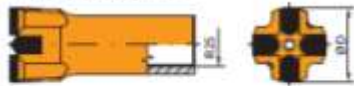

Diameter		Flushing holes (mm)		Catalogue no.
		Side	Front	
mm	inch	No x Size	No x Size	
35	1 3/8	2 x 5	-	D41035R2502
38	1 1/2	2 x 5	-	D41038R2502
41	1 5/8	2 x 5	-	D41041R2502
43	1 7/8	2 x 6	-	D41043R2502
45	1 7/8	2 x 6	-	D41045R2502
48	1 7/8	2 x 6	-	D41048R2502
51	2	2 x 6	-	D41051R2502
35	1 3/8	2 x 5	1 x 4.5	D42035R2502
38	1 1/2	2 x 5	1 x 4.5	D42038R2502
41	1 5/8	2 x 5	1 x 4.5	D42041R2502
43	1 7/8	2 x 5	1 x 4.5	D42043R2502
45	1 7/8	2 x 5	1 x 4.5	D42045R2502
48	1 7/8	2 x 5	1 x 5	D42048R2502
51	2	2 x 5	1 x 5	D42051R2502

Shank rod, Hex 22 - R25

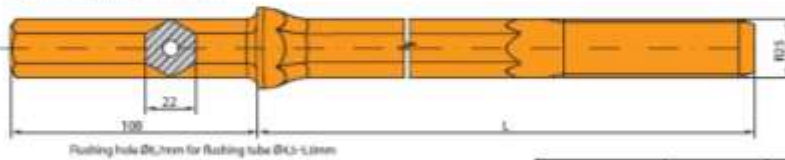

Hex		Thread	Dimensions			Catalogue no.
			Length			
mm	inch		mm	ft	inch	
22	3/4	R25	610	2	-	25111061
22	3/4	R25	760	2	6	25111076
22	3/4	R25	1000	3	3 1/2	25111100
22	3/4	R25	1200	3	11	25111120
22	3/4	R25	1600	5	3	25111160
22	3/4	R25	1830	6	-	25111183
22	3/4	R25	2400	7	10 1/2	25111240
22	3/4	R25	3200	10	6	25111320
22	3/4	R25	3660	12	-	25111366
22	3/4	R25	4000	13	1 1/2	25111400

Shank rod, Hex 25 - R25

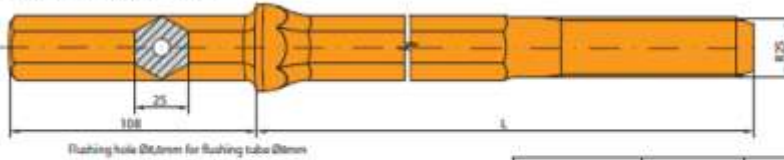

Flushing hole Ø16mm for flushing tube Ø16mm

Hex		Thread	Dimensions			Catalogue no.
mm	inch		Length			
mm	inch		mm	ft	inch	
25	1	R25	610	2	-	25311061
25	1	R25	760	2	6	25311076
25	1	R25	1000	3	3 ½	25311100
25	1	R25	1200	3	11	25311120
25	1	R25	1600	5	3	25311160
25	1	R25	1830	6	-	25311183
25	1	R25	2400	7	10 ½	25311240
25	1	R25	3200	10	6	25311320
25	1	R25	3660	12	-	25311366
25	1	R25	4000	13	1 ½	25311400

Shank rod, Hex 25 - R25

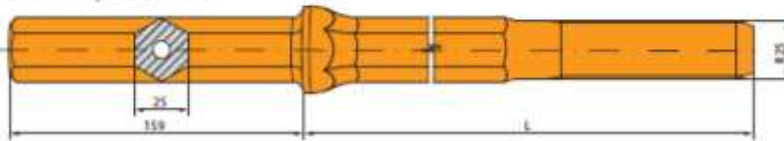

Flushing hole Ø16mm for flushing tube Ø16mm

Hex		Thread	Dimensions			Catalogue no.
mm	inch		Length			
mm	inch		mm	ft	inch	
25	1	R25	610	2	-	25511061
25	1	R25	760	2	6	25511076
25	1	R25	1000	3	3 ½	25511100
25	1	R25	1200	3	11	25511120
25	1	R25	1600	5	3	25511160
25	1	R25	1830	6	-	25511183
25	1	R25	2400	7	10 ½	25511180
25	1	R25	3200	10	6	25511180
25	1	R25	3660	12	-	25511366
25	1	R25	4000	13	1 ½	25511180

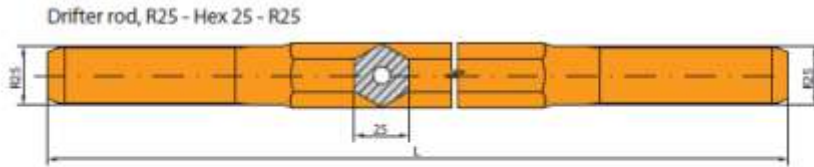

Hex		Threads	Dimensions			Catalogue no.
mm	inch		Length			
			mm	ft	inch	
25	1	R25/R25	610	2	-	20111061
25	1	R25/R25	915	3	-	20111091
25	1	R25/R25	1220	4	-	20111122
25	1	R25/R25	1525	5	-	20111152
25	1	R25/R25	1830	6	-	20111183
25	1	R25/R25	2435	8	-	20111143
25	1	R25/R25	3050	10	-	20111305
25	1	R25/R25	3660	12	-	20111366

Drifter rod, R32 - Hex 25 - R25

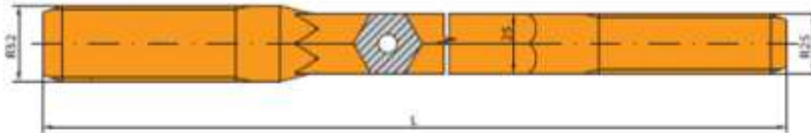

Hex		Threads	Dimensions			Catalogue no.
mm	inch		Length			
			mm	ft	inch	
25	1	R32/R25	610	2	-	20114061
25	1	R32/R25	915	3	-	20114091
25	1	R32/R25	1220	4	-	20114122
25	1	R32/R25	1525	5	-	20114152
25	1	R32/R25	1830	6	-	20114183
25	1	R32/R25	2435	8	-	20114243
25	1	R32/R25	3050	10	-	20114305
25	1	R32/R25	3660	12	-	20114366
25	1	R32/R25	4000	13	1 1/2	20114400

MF-rod, R25 - Hex 25 - R25

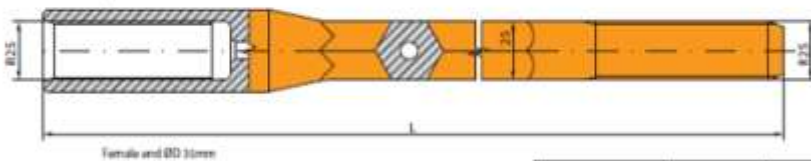

Hex		Threads	Dimensions			Catalogue no.
mm	inch		Length			
			mm	ft	inch	
25	1	R25/R25	610	2	-	26717061
25	1	R25/R25	915	3	-	26717915
25	1	R25/R25	1220	4	-	26717122
25	1	R25/R25	1525	5	-	26717152
25	1	R25/R25	1830	6	-	26717183
25	1	R25/R25	2435	8	-	26717243
25	1	R25/R25	3050	10	-	26717305
25	1	R25/R25	3660	12	-	26717366

Travaux souterrains

R25

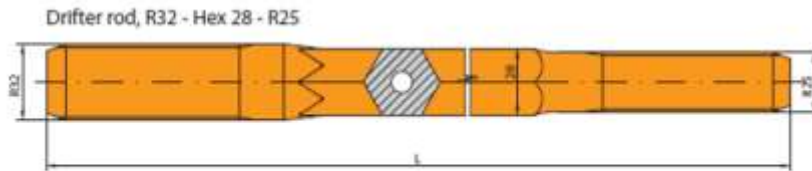

Hex		Threads	Dimensions			Catalogue no.
mm	inch		Length			
			mm	ft	inch	
28	1 1/8	R32/R25	610	2	-	28022061
28	1 1/8	R32/R25	915	3	-	28022091
28	1 1/8	R32/R25	1220	4	-	28022122
28	1 1/8	R32/R25	1525	5	-	28022152
28	1 1/8	R32/R25	1830	6	-	28022183
28	1 1/8	R32/R25	2435	8	-	28022243
28	1 1/8	R32/R25	3050	10	-	28022305
28	1 1/8	R32/R25	3660	12	-	28022366
28	1 1/8	R32/R25	4000	13	1 1/2	28022400

Coupling sleeve R25



Diameter		Threads	Length		Catalogue no.
mm	inch		mm	inch	
34	1 3/16	R25/R25	150	5 7/16	3911100

Coupling sleeve R32 - R25

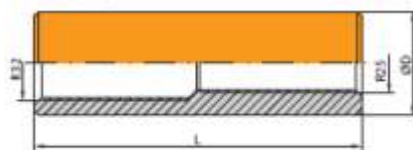

Diameter		Threads	Length		Catalogue no.
mm	inch		mm	inch	
44	1 7/16	R32/R25	150	5 7/16	3911400

Button bit, Type D46



Button bit, Type D47

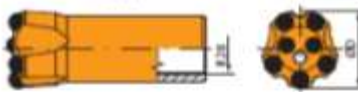

Button bit, Type D49

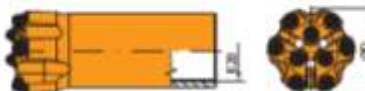

Diameter		Flushing holes (mm)		Buttons (mm)		Catalogue no.
		Side	Front	Gauge	Front	
mm	inch	No x Size	No x Size	No x Size	No x Size	
37	1 7/8	-	2 x 5	4 x 8	2 x 7	D46037R2805R
37	1 7/8	-	2 x 5	4 x 8	2 x 7	D46037R2805S
38	1 1/2	-	2 x 5	4 x 9	2 x 7	D46038R2805R
38	1 1/2	-	2 x 5	4 x 9	2 x 7	D46038R2805S
41	1 3/4	-	2 x 6	4 x 9	2 x 8	D46041R2805R
41	1 3/4	-	2 x 6	4 x 9	2 x 8	D46041R2805S
43	1 11/16	-	2 x 6	4 x 10	2 x 8	D46043R2805R
43	1 11/16	-	2 x 6	4 x 10	2 x 8	D46043R2805S
45	1 7/8	-	2 x 6	4 x 10	2 x 9	D46045R2805R
45	1 7/8	-	2 x 6	4 x 10	2 x 9	D46045R2805S
37	1 7/8	1 x 6	1 x 5	5 x 8	2 x 7	D47037R2805R
37	1 7/8	1 x 6	1 x 5	5 x 8	2 x 7	D47037R2805S
38	1 1/2	1 x 6	1 x 5	5 x 9	2 x 7	D47038R2805R
38	1 1/2	1 x 6	1 x 5	5 x 9	2 x 7	D47038R2805S
41	1 3/4	1 x 6	1 x 5	5 x 9	2 x 8	D47041R2805R
41	1 3/4	1 x 6	1 x 5	5 x 9	2 x 8	D47041R2805S
43	1 11/16	1 x 6	1 x 5	5 x 10	2 x 8	D47043R2805R
43	1 11/16	1 x 6	1 x 5	5 x 10	2 x 8	D47043R2805S
45	1 7/8	1 x 6	1 x 5	5 x 10	2 x 9	D47045R2805R
45	1 7/8	1 x 6	1 x 5	5 x 10	2 x 9	D47045R2805S
37	1 7/8	1 x 5	3 x 5	6 x 7	3 x 7	D49037R2805R
37	1 7/8	1 x 5	3 x 5	6 x 7	3 x 7	D49037R2805S
38	1 1/2	1 x 5	3 x 5	6 x 8	3 x 7	D49038R2805R
38	1 1/2	1 x 5	3 x 5	6 x 8	3 x 7	D49038R2805S
41	1 3/4	1 x 5	3 x 5	6 x 8	3 x 7	D49041R2805R
41	1 3/4	1 x 5	3 x 5	6 x 8	3 x 7	D49041R2805S
43	1 11/16	1 x 5	3 x 5	6 x 9	3 x 8	D49043R2805R
43	1 11/16	1 x 5	3 x 5	6 x 9	3 x 8	D49043R2805S
45	1 7/8	1 x 5	3 x 5	6 x 10	3 x 8	D49045R2805R
45	1 7/8	1 x 5	3 x 5	6 x 10	3 x 8	D49045R2805S
48	1 3/4	1 x 5	3 x 5	6 x 10	3 x 9	D49048R2805R
48	1 3/4	1 x 5	3 x 5	6 x 10	3 x 9	D49048R2805S
51	2	1 x 5	3 x 5	6 x 10	3 x 9	D49051R2805R
51	2	1 x 5	3 x 5	6 x 10	3 x 9	D49051R2805S

Reaming bit, Type D51

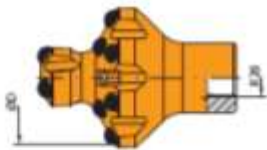

Reaming equipment, Type D50

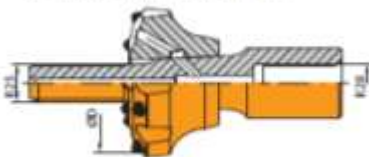

Diameter		Flushing holes (mm)		Buttons (mm)		Catalogue no.
mm	inch	Side	Front	Gauge	Front	
		No x Size	No x Size	No x Size	No x Size	
64	2 1/2	-	4 x 5	8 x 9	7 x 8	D51064R2805R
64	2 1/2	-	4 x 5	8 x 9	7 x 8	D51064R2805S
76	3	-	4 x 5	8 x 10	7 x 9	D51076R2805R
76	3	-	4 x 5	8 x 10	7 x 9	D51076R2805S
89	3 1/2	-	4 x 5	8 x 12	7 x 10	D51089R2805R
89	3 1/2	-	4 x 5	8 x 12	7 x 10	D51089R2805S
102	4	-	4 x 5	8 x 13	7 x 13	D51102R2805R
102	4	-	4 x 5	8 x 13	7 x 13	D51102R2805S
115	4 1/2	-	4 x 6	8 x 14	7 x 13	D51115R2805R
115	4 1/2	-	4 x 6	8 x 14	7 x 13	D51115R2805S
127	5	-	4 x 6	8 x 15	7 x 14	D51127R2805R
127	5	-	4 x 6	8 x 15	7 x 14	D51127R2805S
64	2 1/2	-	2 x 5	8 x 9	4 x 8	D50064R28R2505R
64	2 1/2	-	2 x 5	8 x 9	4 x 8	D50064R28R2505S
76	3	-	2 x 5	8 x 10	4 x 10	D50076R28R2505R
76	3	-	2 x 5	8 x 10	4 x 10	D50076R28R2505S
89	3 1/2	-	2 x 5	8 x 10	6 x 10	D50089R28R2505R
89	3 1/2	-	2 x 5	8 x 10	6 x 10	D50089R28R2505S
102	4	-	2 x 5	8 x 12	4 x 12	D50102R28R2505R
102	4	-	2 x 5	8 x 12	4 x 12	D50102R28R2505S
115	4 1/2	-	2 x 5	8 x 12	6 x 12	D50115R28R2505R
115	4 1/2	-	2 x 5	8 x 12	6 x 12	D50115R28R2505S
127	5	-	2 x 5	8 x 12	8 x 12	D50127R28R2505R
127	5	-	2 x 5	8 x 12	8 x 12	D50127R28R2505S

Chisel bit, Type D41

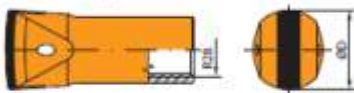

Cross bit, Type D42

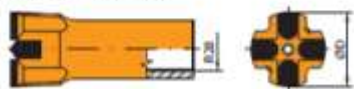

Diameter		Flushing holes (mm)		Catalogue no.
mm	inch	Side	Front	
		No x Size	No x Size	
38	1 1/2	2 x 5	-	D41038R2802
41	1 1/2	2 x 5	-	D41041R2802
43	1 1/2	2 x 6	-	D41043R2802
45	1 1/2	2 x 6	-	D41045R2802
48	1 1/2	2 x 6	-	D41048R2802
51	2	2 x 6	-	D41051R2802
38	1 1/2	2 x 5	1 x 4,5	D42038R2802
41	1 1/2	2 x 5	1 x 4,5	D42041R2802
43	1 1/2	2 x 5	1 x 4,5	D42043R2802
45	1 1/2	2 x 5	1 x 4,5	D42045R2802
48	1 1/2	2 x 5	1 x 5	D42048R2802
51	2	2 x 5	1 x 5	D42051R2802

Shank rod, Hex 25- R28

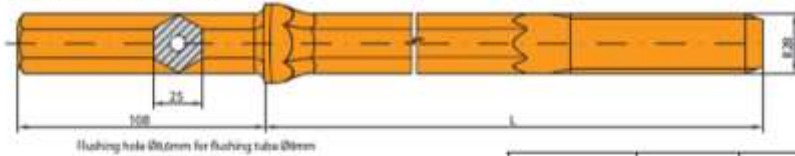

Hex		Thread	Dimensions			Catalogue no.
mm	inch		Length			
			mm	ft	inch	
25	1	R25	610	2	-	25318061
25	1	R25	760	2	6	25318076
25	1	R25	1000	3	3 1/2	25318100
25	1	R25	1220	4	-	25318122
25	1	R25	1600	5	3	25318160
25	1	R25	1830	6	-	25318183
25	1	R25	2435	8	-	25318243
25	1	R25	3050	10	-	25318305

Drifter rod, R28 - Hex 28 - R28

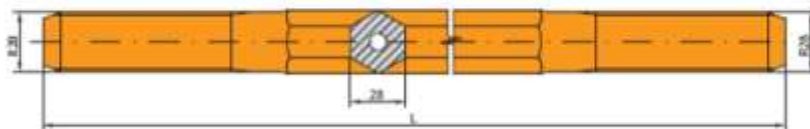

Hex		Threads	Dimensions			Catalogue no.
mm	inch		Length			
			mm	ft	inch	
28	1 1/4	R28/R28	1220	4	-	28698122
28	1 1/4	R28/R28	1525	5	-	28698152
28	1 1/4	R28/R28	1830	6	-	28698183
28	1 1/4	R28/R28	2435	8	-	28698243
28	1 1/4	R28/R28	3050	10	-	28698305
28	1 1/4	R28/R28	3660	12	-	28698366
28	1 1/4	R28/R28	4305	14	1 1/2	28698430

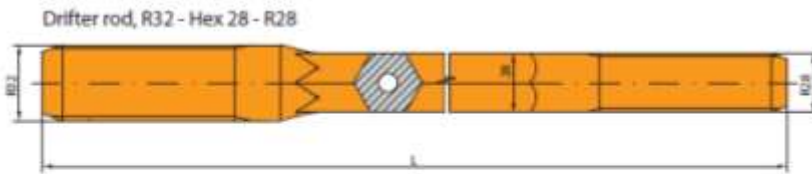

Hex		Threads	Dimensions			Catalogue no.
mm	inch		Length			
			mm	ft	inch	
28	1 1/4	R32/R28	1220	4	-	28691122
28	1 1/4	R32/R28	1525	5	-	28691152
28	1 1/4	R32/R28	1830	6	-	28691183
28	1 1/4	R32/R28	2435	8	-	28691243
28	1 1/4	R32/R28	3050	10	-	28691305
28	1 1/4	R32/R28	3660	12	-	28691366
28	1 1/4	R32/R28	4305	14	1 1/4	28698430

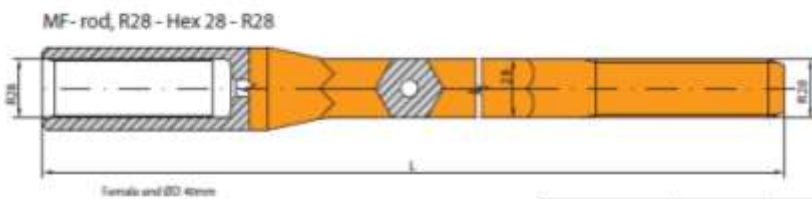

Hex		Threads	Dimensions			Catalogue no.
mm	inch		Length			
			mm	ft	inch	
28	1 1/4	R28/R28	1220	4	-	26818122
28	1 1/4	R28/R28	1525	5	-	26818152
28	1 1/4	R28/R28	1830	6	-	26818183
28	1 1/4	R28/R28	2435	8	-	26818243
28	1 1/4	R28/R28	3050	10	-	26818305
28	1 1/4	R28/R28	3660	12	-	26818366
28	1 1/4	R28/R28	4305	14	1 1/4	26818430

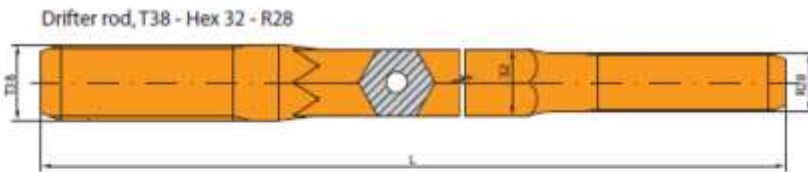

Hex		Threads	Dimensions			Catalogue no.
mm	inch		Length			
			mm	ft	inch	
32	1 ¼	T38/R28	1830	6	-	21872183
32	1 ¼	T38/R28	2435	8	-	21872243
32	1 ¼	T38/R28	3050	10	-	21872305
32	1 ¼	T38/R28	3660	12	-	21872366
32	1 ¼	T38/R28	4305	14	1 ½	21872430

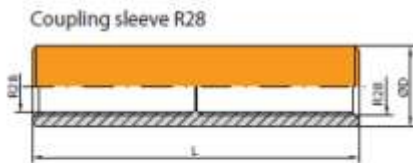

Diameter		Threads	Length		Catalogue no.
mm	inch		mm	inch	
38	1 ½	R28/R28	150	5 7/16	3981800

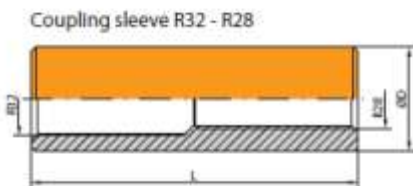

Diameter		Threads	Length		Catalogue no.
mm	inch		mm	inch	
44	1 7/16	R32/R28	150	5 7/16	3981400

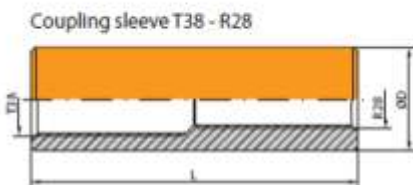

Diameter		Threads	Length		Catalogue no.
mm	inch		mm	inch	
55	2 1/8	T38/R28	165	6 1/2	3927800

Button bit, Type D47

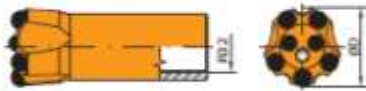

Button bit, Type D48



Button bit, Type D49

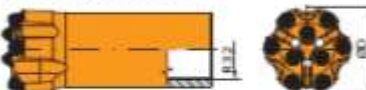

Diameter		Flushing holes (mm)		Buttons (mm)		Catalogue no.
		Side	Front	Gauge	Front	
mm	inch	No x Size	No x Size	No x Size	No x Size	
43	1 1/16	2 x 6	1 x 5	5 x 10	2 x 8	D47043R3205R
43	1 1/16	2 x 6	1 x 5	5 x 10	2 x 8	D47043R3205S
45	1 1/8	2 x 6	1 x 5	5 x 10	2 x 9	D47045R3205R
45	1 1/8	2 x 6	1 x 5	5 x 10	2 x 9	D47045R3205S
48	1 3/8	2 x 7	1 x 6	5 x 11	2 x 9	D47048R3205R
48	1 3/8	2 x 7	1 x 6	5 x 11	2 x 9	D47048R3205S
51	2	2 x 7	1 x 6	5 x 12	2 x 10	D47051R3205R
51	2	2 x 7	1 x 6	5 x 12	2 x 10	D47051R3205S
43	1 1/16	-	2 x 6	6 x 9	2 x 9	D48043R3205R
43	1 1/16	-	2 x 6	6 x 9	2 x 9	D48043R3205S
45	1 1/8	-	2 x 6	6 x 10	2 x 9	D48045R3205R
45	1 1/8	-	2 x 6	6 x 10	2 x 9	D48045R3205S
48	1 3/8	-	2 x 7	6 x 10	2 x 9	D48048R3205R
48	1 3/8	-	2 x 7	6 x 10	2 x 9	D48048R3205S
51	2	-	2 x 7	6 x 11	2 x 9	D48051R3205R
51	2	-	2 x 7	6 x 11	2 x 9	D48051R3205S
54	2 1/8	-	2 x 7	6 x 11	2 x 10	D48054R3205R
54	2 1/8	-	2 x 7	6 x 11	2 x 10	D48054R3205S
45	1 1/8	1 x 5	3 x 5	6 x 10	3 x 8	D49045R3205R
45	1 1/8	1 x 5	3 x 5	6 x 10	3 x 8	D49045R3205S
48	1 3/8	1 x 5	3 x 5	6 x 10	3 x 9	D49048R3205R
48	1 3/8	1 x 5	3 x 5	6 x 10	3 x 9	D49048R3205S
51	2	1 x 6	3 x 5	6 x 10	3 x 9	D49051R3205R
51	2	1 x 6	3 x 5	6 x 10	3 x 9	D49051R3205S
54	2 1/8	1 x 6	3 x 6	6 x 11	3 x 9	D49054R3205R
54	2 1/8	1 x 6	3 x 6	6 x 11	3 x 9	D49054R3205S
57	2 1/4	1 x 6	3 x 6	6 x 11	3 x 10	D49057R3205R
57	2 1/4	1 x 6	3 x 6	6 x 11	3 x 10	D49057R3205S
61	2 3/8	1 x 6	3 x 6	6 x 12	3 x 10	D49061R3205R
61	2 3/8	1 x 6	3 x 6	6 x 12	3 x 10	D49061R3205S
64	2 1/2	1 x 6	3 x 6	6 x 12	3 x 11	D49064R3205R
64	2 1/2	1 x 6	3 x 6	6 x 12	3 x 11	D49064R3205S

Button bit, Retrac, Type D59

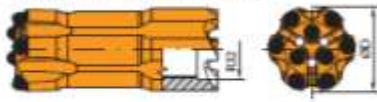

Button bit, Type D62

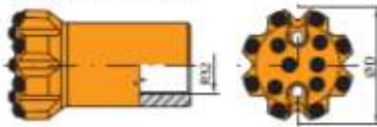

Diameter		Flushing holes (mm)		Buttons (mm)		Catalogue no.
		Side	Front	Gauge	Front	
mm	inch	No x Size	No x Size	No x Size	No x Size	
51	2	1 x 6	3 x 5	6 x 10	3 x 9	D59051R3205R
51	2	1 x 6	3 x 5	6 x 10	3 x 9	D59051R3205S
54	2 1/4	1 x 6	3 x 6	6 x 11	3 x 9	D59054R3205R
54	2 1/4	1 x 6	3 x 6	6 x 11	3 x 9	D59054R3205S
57	2 1/4	1 x 6	3 x 6	6 x 11	3 x 10	D59057R3205R
57	2 1/4	1 x 6	3 x 6	6 x 11	3 x 10	D59057R3205S
61	2 3/8	1 x 6	3 x 6	6 x 12	3 x 10	D59061R3205R
61	2 3/8	1 x 6	3 x 6	6 x 12	3 x 10	D59061R3205S
64	2 1/2	1 x 6	3 x 6	6 x 12	3 x 11	D59064R3205R
64	2 1/2	1 x 6	3 x 6	6 x 12	3 x 11	D59064R3205S
64	2 1/2	-	2 x 8	8 x 11	4 x 10	D62064R3215R
70	2 3/4	-	2 x 8	8 x 12	4 x 11	D62070R3215R
76	3	-	2 x 8	8 x 12	4 x 12	D62076R3215R
89	3 1/2	-	2 x 8	8 x 13	5 x 12	D62089R3215R
102	4	-	2 x 9	8 x 14	6 x 13	D62102R3215R

Button bit, Type D63

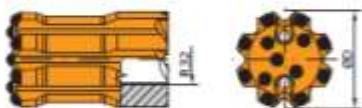

Reaming bit, Type D54

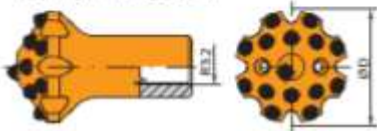

Diameter		Flushing holes (mm)		Buttons (mm)		Catalogue no.
		Side	Front	Gauge	Front	
mm	inch	No x Size	No x Size	No x Size	No x Size	
64	2 1/2	-	2 x 8	8 x 11	4 x 10	D63064R3215R
70	2 3/4	-	2 x 8	8 x 12	4 x 11	D63070R3215R
76	3	-	2 x 8	8 x 12	4 x 12	D63076R3215R
89	3 1/2	-	2 x 8	8 x 13	5 x 12	D63089R3215R
102	4	-	2 x 9	8 x 14	6 x 13	D63102R3215R
76	3	-	2 x 8	8 x 12	7 x 11	D54076R3205R
76	3	-	2 x 8	8 x 12	7 x 11	D54076R3205S
89	3 1/2	-	2 x 8	8 x 12	7 x 12	D54089R3205R
89	3 1/2	-	2 x 8	8 x 12	7 x 12	D54089R3205S
102	4	-	2 x 9	8 x 13	9 x 13	D54102R3205R
102	4	-	2 x 9	8 x 13	9 x 13	D54102R3205S

Diameter		Flushing holes (mm)		Buttons (mm)		Catalogue no.
mm	inch	Side	Front	Gauge	Front	
		No x Size	No x Size	No x Size	No x Size	
Reaming bit, Type D51						
76	3	-	4 x 6	8 x 10	7 x 9	D51076R3205R
76	3	-	4 x 6	8 x 10	7 x 9	D51076R3205S
89	3 1/2	-	4 x 6	8 x 12	7 x 10	D51089R3205R
89	3 1/2	-	4 x 6	8 x 12	7 x 10	D51089R3205S
102	4	-	4 x 7	8 x 13	7 x 13	D51102R3205R
102	4	-	4 x 7	8 x 13	7 x 13	D51102R3205S
115	4 1/2	-	4 x 7	8 x 14	7 x 13	D51115R3205R
115	4 1/2	-	4 x 7	8 x 14	7 x 13	D51115R3205S
Reaming equipment, Type D50						
64	2 1/2	-	2 x 6	8 x 9	4 x 8	D50064R32R2805R
64	2 1/2	-	2 x 6	8 x 9	4 x 8	D50064R32R2805S
76	3	-	2 x 6	8 x 10	4 x 10	D50076R32R2805R
76	3	-	2 x 6	8 x 10	4 x 10	D50076R32R2805S
89	3 1/2	-	2 x 6	8 x 10	6 x 10	D50089R32R2805R
89	3 1/2	-	2 x 6	8 x 10	6 x 10	D50089R32R2805S
102	4	-	2 x 6	8 x 12	4 x 12	D50102R32R2805R
102	4	-	2 x 6	8 x 12	4 x 12	D50102R32R2805S
115	4 1/2	-	2 x 6	8 x 12	6 x 12	D50115R32R2805R
115	4 1/2	-	2 x 6	8 x 12	6 x 12	D50115R32R2805S

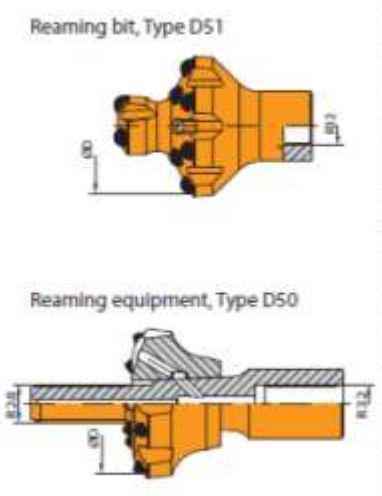

Diameter		Flushing holes (mm)		Catalogue no.
D		Side	Front	
mm	inch	No x Size	No x Size	
43	1 1/2	2 x 6	-	D41043R3202
45	1 3/4	2 x 7	-	D41045R3202
48	1 7/8	2 x 7	-	D41048R3202
51	2	2 x 7	-	D41051R3202
54	2 1/4	2 x 7	-	D41054R3202
43	1 1/2	2 x 6	1 x 5	D42043R3202
45	1 3/4	2 x 6	1 x 5	D42045R3202
48	1 7/8	2 x 6	1 x 6	D42048R3202
51	2	2 x 6	1 x 6	D42051R3202
54	2 1/4	2 x 6	1 x 6	D42054R3202
45	1 3/4	2 x 6	1 x 5	D52045R3202
48	1 7/8	2 x 6	1 x 6	D52048R3202
51	2	2 x 6	1 x 6	D52051R3202
54	2 1/4	2 x 6	1 x 6	D52054R3202
57	2 1/4	2 x 6	1 x 6	D52057R3202
64	2 1/2	2 x 6	1 x 6	D52064R3202
76	3	2 x 6	1 x 6	D52076R3202

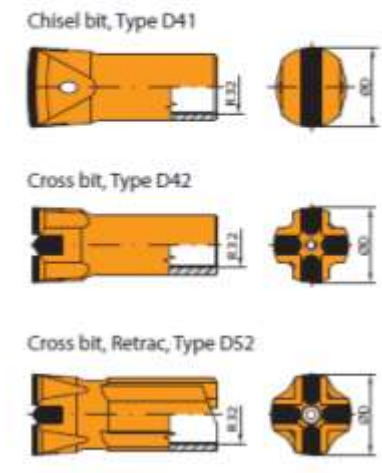

Shank rod, Hex 25 - R32

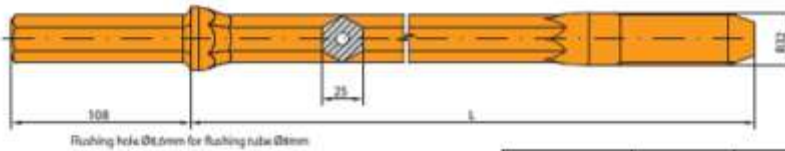

Flushing hole Ø16mm for flushing tube Ø20mm

Hex		Thread	Dimensions			Catalogue no.
mm	inch		Length			
			mm	ft	inch	
25	1	R32	610	2	-	25314061
25	1	R32	760	2	6	25314076
25	1	R32	1000	3	3 ½	25314100
25	1	R32	1220	4	-	25314122
25	1	R32	1600	5	3	25314160
25	1	R32	1830	6	-	25314183
25	1	R32	2435	8	-	25314243
25	1	R32	3050	10	-	25314305
25	1	R32	3660	12	-	25314366

Drifter rod, R32 - Hex 32 - R32

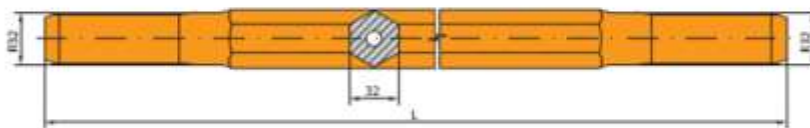

Hex		Threads	Dimensions			Catalogue no.
mm	inch		Length			
			mm	ft	inch	
32	1 ¼	R32/R32	915	3	-	21414091
32	1 ¼	R32/R32	1000	3	3 ½	21414100
32	1 ¼	R32/R32	1220	4	-	21414122
32	1 ¼	R32/R32	1525	5	-	21414152
32	1 ¼	R32/R32	1830	6	-	21414183
32	1 ¼	R32/R32	2435	8	-	21414243
32	1 ¼	R32/R32	3050	10	-	21414305
32	1 ¼	R32/R32	3660	12	-	21414366
32	1 ¼	R32/R32	4305	14	1 ½	21414430
32	1 ¼	R32/R32	4915	16	-	21414491

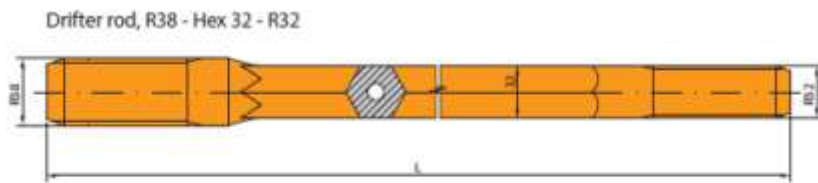

Hex		Threads	Dimensions			Catalogue no.
mm	inch		Length			
			mm	ft	inch	
32	1 ¼	R38/R32	915	3	-	21412091
32	1 ¼	R38/R32	1000	3	3 ½	21412100
32	1 ¼	R38/R32	1220	4	-	21412122
32	1 ¼	R38/R32	1525	5	-	21412152
32	1 ¼	R38/R32	1830	6	-	21412183
32	1 ¼	R38/R32	2435	8	-	21412243
32	1 ¼	R38/R32	3050	10	-	21412305
32	1 ¼	R38/R32	3660	12	-	21412366
32	1 ¼	R38/R32	4305	14	1 ½	21412430
32	1 ¼	R38/R32	4915	16	-	21412491

Travaux souterrains

R32

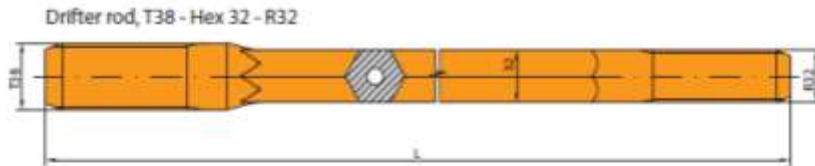

Hex		Threads	Dimensions			Catalogue no.
mm	inch		Length			
			mm	ft	inch	
32	1 1/4	T38/R32	915	3	-	21472091
32	1 1/4	T38/R32	1000	3	3 1/2	21472100
32	1 1/4	T38/R32	1220	4	-	21472122
32	1 1/4	T38/R32	1525	5	-	21472152
32	1 1/4	T38/R32	1830	6	-	21472183
32	1 1/4	T38/R32	2435	8	-	21472243
32	1 1/4	T38/R32	3050	10	-	21472305
32	1 1/4	T38/R32	3660	12	-	21472366
32	1 1/4	T38/R32	4305	14	1 1/2	21472430
32	1 1/4	T38/R32	4915	16	-	21472491

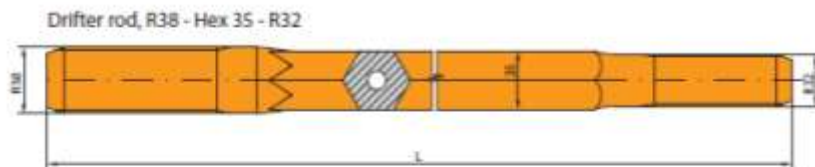

Hex		Threads	Dimensions			Catalogue no.
mm	inch		Length			
			mm	ft	inch	
35	1 1/4	R38/R32	915	3	-	19412091
35	1 1/4	R38/R32	1000	3	3 1/2	19412100
35	1 1/4	R38/R32	1220	4	-	19412122
35	1 1/4	R38/R32	1525	5	-	19412152
35	1 1/4	R38/R32	1830	6	-	19412183
35	1 1/4	R38/R32	2435	8	-	19412243
35	1 1/4	R38/R32	3050	10	-	19412305
35	1 1/4	R38/R32	3660	12	-	19412366
35	1 1/4	R38/R32	4305	14	1 1/2	19412430
35	1 1/4	R38/R32	4915	16	-	19412491

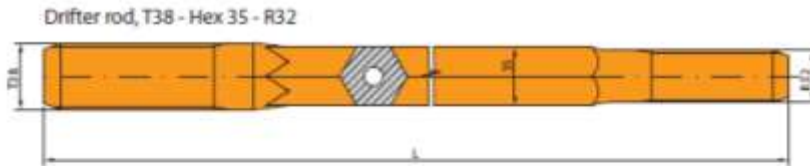

Hex		Threads	Dimensions			Catalogue no.
mm	inch		Length			
			mm	ft	inch	
35	1 1/4	T38/R32	915	3	-	19472091
35	1 1/4	T38/R32	1000	3	3 1/2	19472100
35	1 1/4	T38/R32	1220	4	-	19472122
35	1 1/4	T38/R32	1525	5	-	19472152
35	1 1/4	T38/R32	1830	6	-	19472183
35	1 1/4	T38/R32	2435	8	-	19472243
35	1 1/4	T38/R32	3050	10	-	19472305
35	1 1/4	T38/R32	3660	12	-	19472366
35	1 1/4	T38/R32	4305	14	1 1/2	19472430
35	1 1/4	T38/R32	4915	16	-	19472491

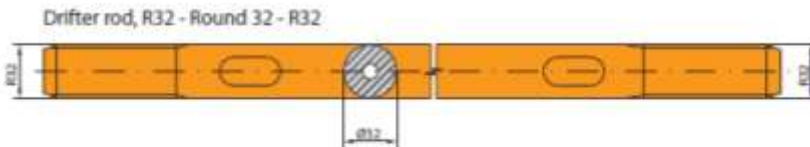

Hex		Threads	Dimensions			Catalogue no.
mm	inch		Length			
			mm	ft	inch	
32	1 1/4	R32/R32	915	3	-	22414091
32	1 1/4	R32/R32	1000	3	3 1/2	22414100
32	1 1/4	R32/R32	1220	4	-	22414122
32	1 1/4	R32/R32	1525	5	-	22414152
32	1 1/4	R32/R32	1830	6	-	22414183
32	1 1/4	R32/R32	2435	8	-	22414243
32	1 1/4	R32/R32	3050	10	-	22414305
32	1 1/4	R32/R32	3660	12	-	22414366
32	1 1/4	R32/R32	4305	14	1 1/2	22414430
32	1 1/4	R32/R32	4915	16	-	22414491

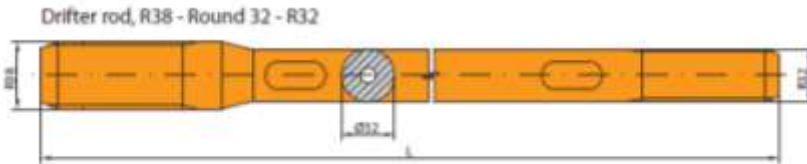

Hex		Threads	Dimensions			Catalogue no.
mm	inch		Length			
			mm	ft	inch	
32	1 1/4	R38/R32	915	3	-	22412091
32	1 1/4	R38/R32	1000	3	3/8	22412100
32	1 1/4	R38/R32	1220	4	-	22412122
32	1 1/4	R38/R32	1525	5	-	22412152
32	1 1/4	R38/R32	1830	6	-	22412183
32	1 1/4	R38/R32	2435	8	-	22412243
32	1 1/4	R38/R32	3050	10	-	22412305
32	1 1/4	R38/R32	3660	12	-	22412366
32	1 1/4	R38/R32	4305	14	1 1/8	22412430
32	1 1/4	R38/R32	4915	16	-	22412491

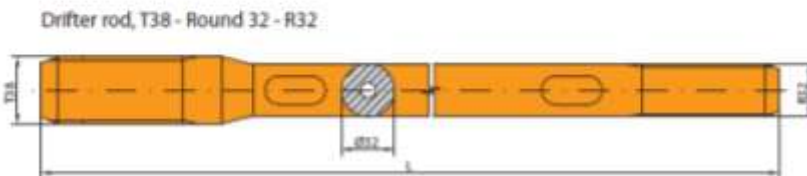

Hex		Threads	Dimensions			Catalogue no.
mm	inch		Length			
			mm	ft	inch	
32	1 1/4	T38/R32	915	3	-	22472091
32	1 1/4	T38/R32	1000	3	3/8	22472100
32	1 1/4	T38/R32	1220	4	-	22472122
32	1 1/4	T38/R32	1525	5	-	22472152
32	1 1/4	T38/R32	1830	6	-	22472183
32	1 1/4	T38/R32	2435	8	-	22472243
32	1 1/4	T38/R32	3050	10	-	22472305
32	1 1/4	T38/R32	3660	12	-	22472366
32	1 1/4	T38/R32	4305	14	1 1/8	22472430
32	1 1/4	T38/R32	4915	16	-	22472491

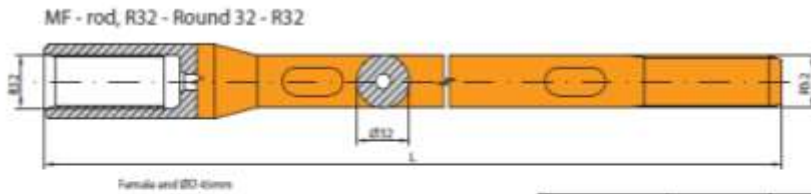

Hex		Threads	Dimensions			Catalogue no.
mm	inch		Length			
			mm	ft	inch	
32	1 ¼	R32/R32	915	3	-	26111091
32	1 ¼	R32/R32	1000	3	3 ½	26111100
32	1 ¼	R32/R32	1220	4	-	26111122
32	1 ¼	R32/R32	1525	5	-	26111152
32	1 ¼	R32/R32	1830	6	-	26111183
32	1 ¼	R32/R32	2435	8	-	26111243
32	1 ¼	R32/R32	3050	10	-	26111305
32	1 ¼	R32/R32	3660	12	-	26111366
32	1 ¼	R32/R32	4305	14	1 ½	26111430
32	1 ¼	R32/R32	4915	16	-	26111491

Coupling sleeve R32

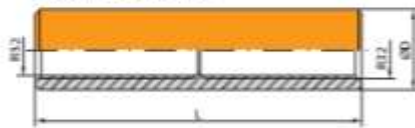

Diameter		Threads	Length		Catalogue no.
mm	inch		mm	inch	
44	1 ¾	R32/R32	150	5 7/8	3941400

Coupling sleeve

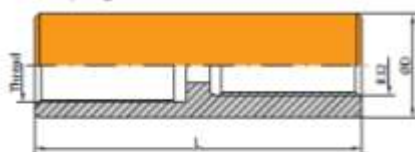

Diameter		Threads	Length		Catalogue no.
mm	inch		mm	inch	
55	2 1/8	R38/R32	170	6 ¾	3941201
55	2 1/8	T38/R32	185	7 3/8	3947201
62	2 ½	T45/R32	185	7 3/8	3937401

Bit adapter coupling

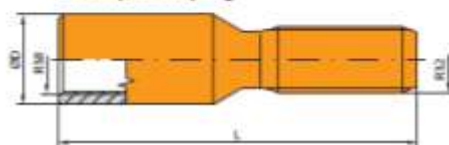

Diameter		Threads	Length		Catalogue no.
mm	inch		mm	inch	
55	2 1/8	R38/R32	230	9	3941206

Button bit, Type D47

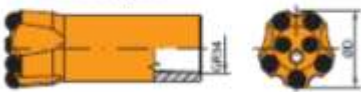

Button bit, Type D48

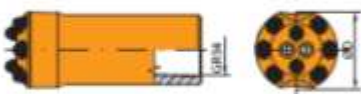

Diameter		Flushing holes (mm)		Buttons (mm)		Catalogue no.
		Side	Front	Gauge	Front	
mm	inch	No x Size	No x Size	No x Size	No x Size	
43	1 1/4	2 x 6	1 x 5	5 x 10	2 x 8	D47043GR3405R
43	1 1/4	2 x 6	1 x 5	5 x 10	2 x 8	D47043GR3405S
45	1 3/8	2 x 6	1 x 5	5 x 10	2 x 9	D47045GR3405R
45	1 3/8	2 x 6	1 x 5	5 x 10	2 x 9	D47045GR3405S
48	1 3/4	2 x 7	1 x 6	5 x 11	2 x 9	D47048GR3405R
48	1 3/4	2 x 7	1 x 6	5 x 11	2 x 9	D47048GR3405S
51	2	2 x 7	1 x 6	5 x 12	2 x 10	D47051GR3405R
51	2	2 x 7	1 x 6	5 x 12	2 x 10	D47051GR3405S
54	2 1/4	2 x 7	1 x 6	5 x 12	2 x 11	D47054GR3405R
54	2 1/4	2 x 7	1 x 6	5 x 12	2 x 11	D47054GR3405S
57	2 1/4	2 x 7	1 x 6	5 x 13	2 x 11	D47057GR3405R
57	2 1/4	2 x 7	1 x 6	5 x 13	2 x 11	D47057GR3405S
43	1 1/4	-	2 x 6	6 x 9	2 x 9	D48043GR3405R
43	1 1/4	-	2 x 6	6 x 9	2 x 9	D48043GR3405S
45	1 3/8	-	2 x 6	6 x 10	2 x 9	D48045GR3405R
45	1 3/8	-	2 x 6	6 x 10	2 x 9	D48045GR3405S
48	1 3/4	-	2 x 7	6 x 10	2 x 9	D48048GR3405R
48	1 3/4	-	2 x 7	6 x 10	2 x 9	D48048GR3405S
51	2	-	2 x 7	6 x 11	2 x 9	D48051GR3405R
51	2	-	2 x 7	6 x 11	2 x 9	D48051GR3405S
54	2 1/4	-	2 x 7	6 x 11	2 x 10	D48054GR3405R
54	2 1/4	-	2 x 7	6 x 11	2 x 10	D48054GR3405S
57	2 1/4	-	2 x 7	6 x 12	2 x 10	D48057GR3405R
57	2 1/4	-	2 x 7	6 x 12	2 x 10	D48057GR3405S

Button bit, Type D49

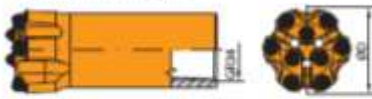

Button bit, Retrac, Type D59



Diameter		Flushing holes (mm)		Buttons (mm)		Catalogue no.
		Side	Front	Gauge	Front	
mm	inch	No x Size	No x Size	No x Size	No x Size	
43	1 11/16	1 x 5	3 x 5	6 x 9	3 x 8	D49043GR3405R
43	1 11/16	1 x 5	3 x 5	6 x 9	3 x 8	D49043GR3405S
45	1 7/8	1 x 5	3 x 5	6 x 10	3 x 8	D49045GR3405R
45	1 7/8	1 x 5	3 x 5	6 x 10	3 x 8	D49045GR3405S
48	1 7/8	1 x 5	3 x 5	6 x 10	3 x 9	D49048GR3405R
48	1 7/8	1 x 5	3 x 5	6 x 10	3 x 9	D49048GR3405S
51	2	1 x 6	3 x 5	6 x 10	3 x 9	D49051GR3405R
51	2	1 x 6	3 x 5	6 x 10	3 x 9	D49051GR3405S
54	2 1/4	1 x 6	3 x 6	6 x 11	3 x 9	D49054GR3405R
54	2 1/4	1 x 6	3 x 6	6 x 11	3 x 9	D49054GR3405S
57	2 1/4	1 x 6	3 x 6	6 x 11	3 x 10	D49057GR3405R
57	2 1/4	1 x 6	3 x 6	6 x 11	3 x 10	D49057GR3405S
51	2	1 x 6	3 x 5	6 x 10	3 x 9	D59051GR3405R
51	2	1 x 6	3 x 5	6 x 10	3 x 9	D59051GR3405S
54	2 1/4	1 x 6	3 x 6	6 x 11	3 x 9	D59054GR3405R
54	2 1/4	1 x 6	3 x 6	6 x 11	3 x 9	D59054GR3405S
57	2 1/4	1 x 6	3 x 6	6 x 11	3 x 10	D59057GR3405R
57	2 1/4	1 x 6	3 x 6	6 x 11	3 x 10	D59057GR3405S
61	2 3/8	1 x 6	3 x 6	6 x 12	3 x 10	D59061GR3405R
61	2 3/8	1 x 6	3 x 6	6 x 12	3 x 10	D59061GR3405S
64	2 5/8	1 x 6	3 x 6	6 x 12	3 x 11	D59064GR3405R
64	2 5/8	1 x 6	3 x 6	6 x 12	3 x 11	D59064GR3405S

Reaming bit, Type D51

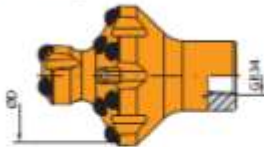

Reaming equipment, Type D50

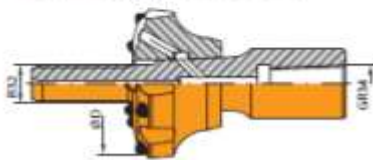

Diameter		Flushing holes (mm)		Buttons (mm)		Catalogue no.
mm	inch	Side	Front	Gauge	Front	
		No x Size	No x Size	No x Size	No x Size	
76	3	-	4 x 6	8 x 10	7 x 9	D51076GR3405R
76	3	-	4 x 6	8 x 10	7 x 9	D51076GR3405S
89	3 1/2	-	4 x 6	8 x 12	7 x 10	D51089GR3405R
89	3 1/2	-	4 x 6	8 x 12	7 x 10	D51089GR3405S
102	4	-	4 x 7	8 x 13	7 x 13	D51102GR3405R
102	4	-	4 x 7	8 x 13	7 x 13	D51102GR3405S
115	4 1/2	-	4 x 7	8 x 14	7 x 13	D51115GR3405R
115	4 1/2	-	4 x 7	8 x 14	7 x 13	D51115GR3405S
76	3	-	2 x 6	8 x 10	4 x 10	D50076GR34R3205R
76	3	-	2 x 6	8 x 10	4 x 10	D50076GR34R3205S
89	3 1/2	-	2 x 6	8 x 10	6 x 10	D50089GR34R3205R
89	3 1/2	-	2 x 6	8 x 10	6 x 10	D50089GR34R3205S
102	4	-	2 x 6	8 x 12	4 x 12	D50102GR34R3205R
102	4	-	2 x 6	8 x 12	4 x 12	D50102GR34R3205S
115	4 1/2	-	2 x 6	8 x 12	6 x 12	D50115GR34R3205R
115	4 1/2	-	2 x 6	8 x 12	6 x 12	D50115GR34R3205S

Cross bit, Type D42

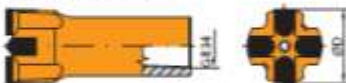

Cross bit, Retrac, Type D52

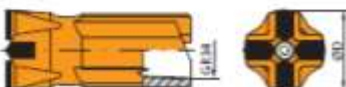

Diameter		Flushing holes (mm)		Catalogue no.
mm	inch	Side	Front	
		No x Size	No x Size	
43	1 1/4	2 x 6	1 x 5	D42043GR3402
45	1 3/8	2 x 6	1 x 5	D42045GR3402
48	1 7/8	2 x 6	1 x 6	D42048GR3402
51	2	2 x 6	1 x 6	D42051GR3402
54	2 1/4	2 x 6	1 x 6	D42054GR3402
45	1 3/8	2 x 6	1 x 5	D52045GR3402
48	1 7/8	2 x 6	1 x 6	D52048GR3402
51	2	2 x 6	1 x 6	D52051GR3402
54	2 1/4	2 x 6	1 x 6	D52054GR3402
57	2 1/4	2 x 6	1 x 6	D52057GR3402
64	2 1/2	2 x 6	1 x 6	D52064GR3402
76	3	2 x 6	1 x 6	D52076GR3402

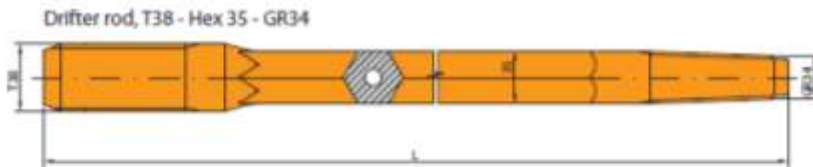

Hex		Threads	Dimensions			Catalogue no.
mm	inch		Length			
			mm	ft	inch	
35	1 3/8	T38/GR34	915	3	-	10H35T38GR34091
35	1 3/8	T38/GR34	1000	3	3/8	10H35T38GR34100
35	1 3/8	T38/GR34	1220	4	-	10H35T38GR34122
35	1 3/8	T38/GR34	1525	5	-	10H35T38GR34152
35	1 3/8	T38/GR34	1830	6	-	10H35T38GR34183
35	1 3/8	T38/GR34	2435	8	-	10H35T38GR34243
35	1 3/8	T38/GR34	3050	10	-	10H35T38GR34305
35	1 3/8	T38/GR34	3660	12	-	10H35T38GR34366
35	1 3/8	T38/GR34	4305	14	1 1/8	10H35T38GR34430
35	1 3/8	T38/GR34	4915	16	-	10H35T38GR34491

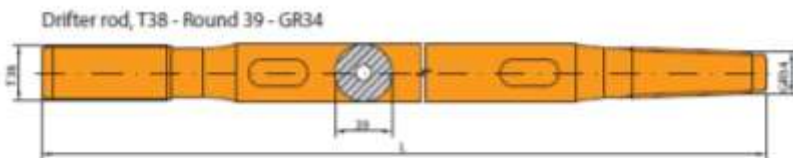

Hex		Threads	Dimensions			Catalogue no.
mm	inch		Length			
			mm	ft	inch	
39	1 1/2	T38/GR34	915	3	-	10R39T38GR34091
39	1 1/2	T38/GR34	1000	3	3/8	10R39T38GR34100
39	1 1/2	T38/GR34	1220	4	-	10R39T38GR34122
39	1 1/2	T38/GR34	1525	5	-	10R39T38GR34152
39	1 1/2	T38/GR34	1830	6	-	10R39T38GR34183
39	1 1/2	T38/GR34	2435	8	-	10R39T38GR34243
39	1 1/2	T38/GR34	3050	10	-	10R39T38GR34305
39	1 1/2	T38/GR34	3660	12	-	10R39T38GR34366
39	1 1/2	T38/GR34	4305	14	1 1/8	10R39T38GR34430
39	1 1/2	T38/GR34	4915	16	-	10R39T38GR34491

Button bit, Type D47

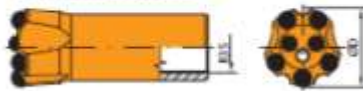

Button bit, Type D48

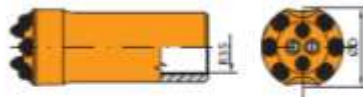

Button bit, Type D49



Diameter		Flushing holes (mm)		Buttons (mm)		Catalogue no.
mm	inch	Side	Front	Gauge	Front	
		No x Size	No x Size	No x Size	No x Size	
45	1 7/8	2 x 6	1 x 5	5 x 10	2 x 9	D47045R3505R
45	1 7/8	2 x 6	1 x 5	5 x 10	2 x 9	D47045R3505S
48	1 7/8	2 x 7	1 x 6	5 x 11	2 x 9	D47048R3505R
48	1 7/8	2 x 7	1 x 6	5 x 11	2 x 9	D47048R3505S
51	2	2 x 7	1 x 6	5 x 12	2 x 10	D47051R3505R
51	2	2 x 7	1 x 6	5 x 12	2 x 10	D47051R3505S
54	2 1/4	2 x 7	1 x 6	5 x 12	2 x 11	D47054R3505R
54	2 1/4	2 x 7	1 x 6	5 x 12	2 x 11	D47054R3505S
45	1 7/8	-	2 x 6	6 x 10	2 x 9	D48045R3505R
45	1 7/8	-	2 x 6	6 x 10	2 x 9	D48045R3505S
48	1 7/8	-	2 x 7	6 x 10	2 x 9	D48048R3505R
48	1 7/8	-	2 x 7	6 x 10	2 x 9	D48048R3505S
51	2	-	2 x 7	6 x 11	2 x 9	D48051R3505R
51	2	-	2 x 7	6 x 11	2 x 9	D48051R3505S
54	2 1/4	-	2 x 7	6 x 11	2 x 10	D48054R3505R
54	2 1/4	-	2 x 7	6 x 11	2 x 10	D48054R3505S
45	1 7/8	1 x 5	3 x 5	6 x 10	3 x 8	D49045R3505R
45	1 7/8	1 x 5	3 x 5	6 x 10	3 x 8	D49045R3505S
48	1 7/8	1 x 5	3 x 5	6 x 10	3 x 9	D49048R3505R
48	1 7/8	1 x 5	3 x 5	6 x 10	3 x 9	D49048R3505S
51	2	1 x 6	3 x 5	6 x 10	3 x 9	D49051R3505R
51	2	1 x 6	3 x 5	6 x 10	3 x 9	D49051R3505S
54	2 1/4	1 x 6	3 x 6	6 x 11	3 x 9	D49054R3505R
54	2 1/4	1 x 6	3 x 6	6 x 11	3 x 9	D49054R3505S
57	2 1/4	1 x 6	3 x 6	6 x 11	3 x 10	D49057R3505R
57	2 1/4	1 x 6	3 x 6	6 x 11	3 x 10	D49057R3505S
61	2 3/8	1 x 6	3 x 6	6 x 12	3 x 10	D49061R3505R
61	2 3/8	1 x 6	3 x 6	6 x 12	3 x 10	D49061R3505S
64	2 1/2	1 x 6	3 x 6	6 x 12	3 x 11	D49064R3505R
64	2 1/2	1 x 6	3 x 6	6 x 12	3 x 11	D49064R3505S

Button bit, Retrac, Type D59



Button bit, Type D62

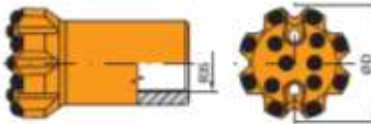

Diameter		Flushing holes (mm)		Buttons (mm)		Catalogue no.
		Side	Front	Gauge	Front	
mm	inch	No x Size	No x Size	No x Size	No x Size	
51	2	1 x 6	3 x 5	6 x 10	3 x 9	D59051R3505R
51	2	1 x 6	3 x 5	6 x 10	3 x 9	D59051R3505S
54	2 1/4	1 x 6	3 x 6	6 x 11	3 x 9	D59054R3505R
54	2 1/4	1 x 6	3 x 6	6 x 11	3 x 9	D59054R3505S
57	2 1/4	1 x 6	3 x 6	6 x 11	3 x 10	D59057R3505R
57	2 1/4	1 x 6	3 x 6	6 x 11	3 x 10	D59057R3505S
61	2 3/8	1 x 6	3 x 6	6 x 12	3 x 10	D59061R3505R
61	2 3/8	1 x 6	3 x 6	6 x 12	3 x 10	D59061R3505S
64	2 1/2	1 x 6	3 x 6	6 x 12	3 x 11	D59064R3505R
64	2 1/2	1 x 6	3 x 6	6 x 12	3 x 11	D59064R3505S
64	2 1/2	-	2 x 9	8 x 11	4 x 10	D62064R3515R
70	2 3/4	-	2 x 9	8 x 12	4 x 11	D62070R3515R
76	3	-	2 x 9	8 x 12	4 x 12	D62076R3515R
89	3 1/2	-	2 x 10	8 x 13	5 x 12	D62089R3515R
102	4	-	2 x 10	8 x 14	6 x 13	D62102R3515R

Button bit, Retrac, Type D63

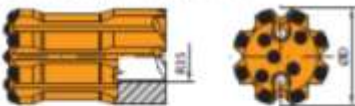

Reaming bit, Type D54

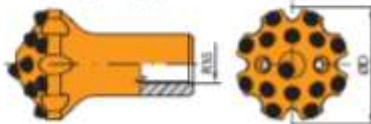

Diameter		Flushing holes (mm)		Buttons (mm)		Catalogue no.
		Side	Front	Gauge	Front	
mm	inch	No x Size	No x Size	No x Size	No x Size	
64	2 1/2	-	2 x 9	8 x 11	4 x 10	D63064R3515R
70	2 3/4	-	2 x 9	8 x 12	4 x 11	D63070R3515R
76	3	-	2 x 9	8 x 12	4 x 12	D63076R3515R
89	3 1/2	-	2 x 10	8 x 13	5 x 12	D63089R3515R
102	4	-	2 x 10	8 x 14	6 x 13	D63102R3515R
76	3	-	2 x 8	8 x 12	7 x 11	D54076R3505R
76	3	-	2 x 8	8 x 12	7 x 11	D54076R3505S
89	3 1/2	-	2 x 8	8 x 12	7 x 12	D54089R3505R
89	3 1/2	-	2 x 8	8 x 12	7 x 12	D54089R3505S
102	4	-	2 x 9	8 x 13	9 x 13	D54102R3505R
102	4	-	2 x 9	8 x 13	9 x 13	D54102R3505S

Reaming bit, Type D51

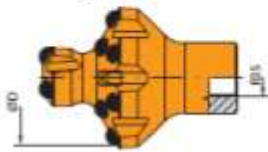

Reaming equipment, Type D50



Diameter		Flushing holes (mm)		Buttons (mm)		Catalogue no.
mm	inch	Side	Front	Gauge	Front	
		No x Size	No x Size	No x Size	No x Size	
76	3	-	4 x 6	8 x 10	7 x 9	D51076R3505R
76	3	-	4 x 6	8 x 10	7 x 9	D51076R3505S
89	3 1/2	-	4 x 6	8 x 12	7 x 10	D51089R3505R
89	3 1/2	-	4 x 6	8 x 12	7 x 10	D51089R3505S
102	4	-	4 x 7	8 x 13	7 x 13	D51102R3505R
102	4	-	4 x 7	8 x 13	7 x 13	D51102R3505S
115	4 1/2	-	4 x 7	8 x 14	7 x 13	D51115R3505R
115	4 1/2	-	4 x 7	8 x 14	7 x 13	D51115R3505S
64	2 1/2	-	2 x 6	8 x 9	4 x 8	D50064R35R3205R
64	2 1/2	-	2 x 6	8 x 9	4 x 8	D50064R35R3205S
76	3	-	2 x 6	8 x 10	4 x 10	D50076R35R3205R
76	3	-	2 x 6	8 x 10	4 x 10	D50076R35R3205S
89	3 1/2	-	2 x 6	8 x 10	6 x 10	D50089R35R3205R
89	3 1/2	-	2 x 6	8 x 10	6 x 10	D50089R35R3205S
102	4	-	2 x 6	8 x 12	4 x 12	D50102R35R3205R
102	4	-	2 x 6	8 x 12	4 x 12	D50102R35R3205S
115	4 1/2	-	2 x 6	8 x 12	6 x 12	D50115R35R3205R
115	4 1/2	-	2 x 6	8 x 12	6 x 12	D50115R35R3205S

Chisel bit, Type D41

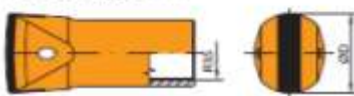

Cross bit, Type D42

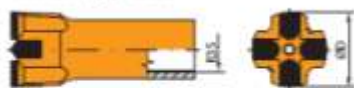

Cross bit, Retrac, Type D52

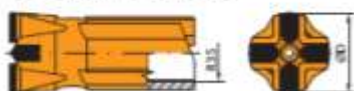

Diameter		Flushing holes (mm)		Catalogue no.
mm	inch	Side	Front	
		No x Size	No x Size	
45	1 3/4	2 x 7	-	D41045R3502
48	1 7/8	2 x 7	-	D41048R3502
51	2	2 x 7	-	D41051R3502
54	2 1/4	2 x 7	-	D41054R3502
45	1 3/4	2 x 6	1 x 6	D42045R3502
48	1 7/8	2 x 6	1 x 6	D42048R3502
51	2	2 x 6	1 x 6	D42051R3502
54	2 1/4	2 x 6	1 x 6	D42054R3502
45	1 3/4	2 x 6	1 x 6	D52045R3502
48	1 7/8	2 x 6	1 x 6	D52048R3502
51	2	2 x 6	1 x 6	D52051R3502
54	2 1/4	2 x 6	1 x 6	D52054R3502
57	2 1/4	2 x 6	1 x 6	D52057R3502
64	2 1/2	2 x 6	1 x 6	D52064R3502
76	3	2 x 6	1 x 6	D52076R3502

Travaux souterrains

R35

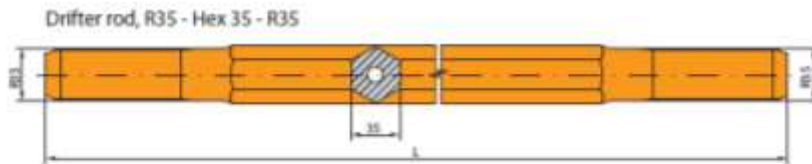

Hex		Threads	Dimensions			Catalogue no.
mm	inch		Length			
			mm	ft	inch	
35	1 1/2	R35/R35	915	3	-	19515091
35	1 1/2	R35/R35	1000	3	3/4	19515100
35	1 1/2	R35/R35	1220	4	-	19515122
35	1 1/2	R35/R35	1525	5	-	19515152
35	1 1/2	R35/R35	1830	6	-	19515183
35	1 1/2	R35/R35	2435	8	-	19515243
35	1 1/2	R35/R35	3050	10	-	19515305
35	1 1/2	R35/R35	3660	12	-	19515366
35	1 1/2	R35/R35	4305	14	1 1/2	19515430
35	1 1/2	R35/R35	4915	16	-	19515491

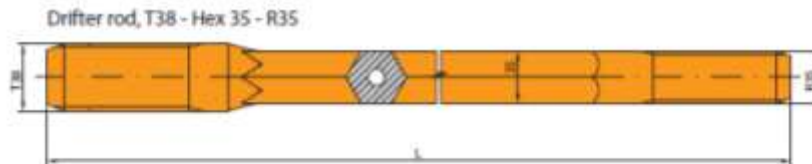

Hex		Threads	Dimensions			Catalogue no.
mm	inch		Length			
			mm	ft	inch	
35	1 1/2	T38/R35	915	3	-	19275091
35	1 1/2	T38/R35	1000	3	3/4	19275100
35	1 1/2	T38/R35	1220	4	-	19275122
35	1 1/2	T38/R35	1525	5	-	19275152
35	1 1/2	T38/R35	1830	6	-	19275183
35	1 1/2	T38/R35	2435	8	-	19275243
35	1 1/2	T38/R35	3050	10	-	19275305
35	1 1/2	T38/R35	3660	12	-	19275366
35	1 1/2	T38/R35	4305	14	1 1/2	19275430
35	1 1/2	T38/R35	4915	16	-	19275491

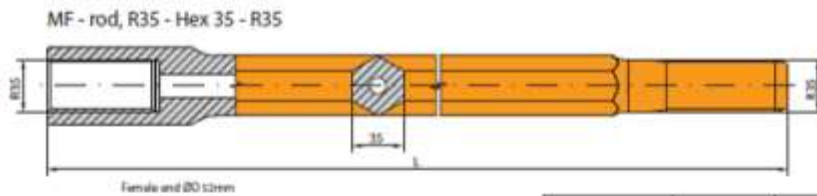

Hex		Threads	Dimensions			Catalogue no.
mm	inch		Length			
			mm	ft	inch	
35	1 1/8	R35/R35	915	3	-	26414091
35	1 1/8	R35/R35	1000	3	3/4	26414100
35	1 1/8	R35/R35	1220	4	-	26414122
35	1 1/8	R35/R35	1525	5	-	26414152
35	1 1/8	R35/R35	1830	6	-	26414183
35	1 1/8	R35/R35	2435	8	-	26414243
35	1 1/8	R35/R35	3050	10	-	26414305
35	1 1/8	R35/R35	3660	12	-	26414366
35	1 1/8	R35/R35	4305	14	1 1/2	26414430
35	1 1/8	R35/R35	4915	16	-	26414491

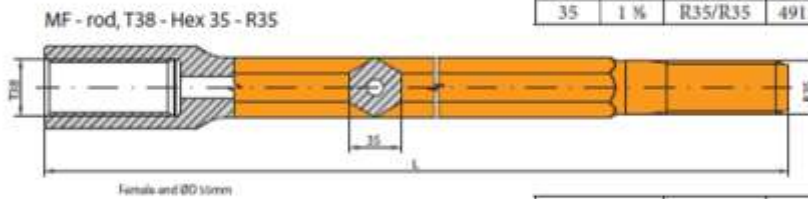

Hex		Threads	Dimensions			Catalogue no.
mm	inch		Length			
			mm	ft	inch	
35	1 1/8	T38/R35	915	3	-	26975091
35	1 1/8	T38/R35	1000	3	3/4	26975100
35	1 1/8	T38/R35	1220	4	-	26975122
35	1 1/8	T38/R35	1525	5	-	26975152
35	1 1/8	T38/R35	1830	6	-	26975183
35	1 1/8	T38/R35	2435	8	-	26975243
35	1 1/8	T38/R35	3050	10	-	26975305
35	1 1/8	T38/R35	3660	12	-	26975366
35	1 1/8	T38/R35	4305	14	1 1/2	26975430
35	1 1/8	T38/R35	4915	16	-	26975491

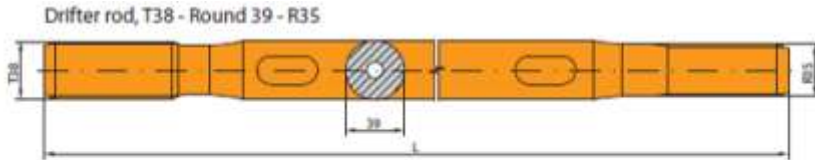

Hex		Threads	Dimensions			Catalogue no.
mm	inch		Length			
			mm	ft	inch	
39	1 1/2	T38/R35	915	3	-	23275091
39	1 1/2	T38/R35	1000	3	3 1/2	23275100
39	1 1/2	T38/R35	1220	4	-	23275122
39	1 1/2	T38/R35	1525	5	-	23275152
39	1 1/2	T38/R35	1830	6	-	23275183
39	1 1/2	T38/R35	2435	8	-	23275243
39	1 1/2	T38/R35	3050	10	-	23275305
39	1 1/2	T38/R35	3660	12	-	23275366
39	1 1/2	T38/R35	4305	14	1 1/2	23275430
39	1 1/2	T38/R35	4915	16	-	23275491

Coupling sleeve R35

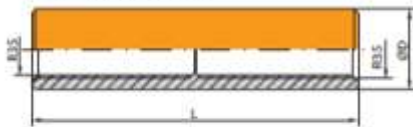

Diameter		Threads	Length		Catalogue no.
mm	inch		mm	inch	
50	1 7/8	R35/R35	150	5 7/8	3953500

Coupling sleeve

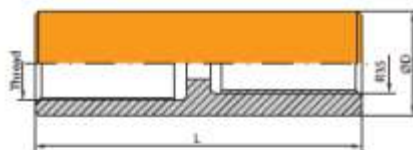

Diameter		Threads	Length		Catalogue no.
mm	inch		mm	inch	
55	2 1/8	T38/R35	185	7 3/8	3953201
62	2 1/2	T45/R35	185	7 3/8	3953301

Bit adapter coupling

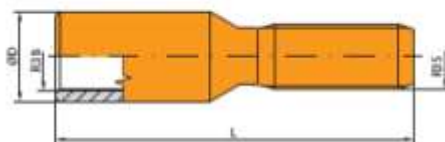

Diameter		Threads	Length		Catalogue no.
mm	inch		mm	inch	
55	2 1/8	R38/R35	230	9	3953206

Button bit, Drop center, Type D60

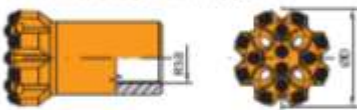

Button bit, Drop center, Retrac, Type D61

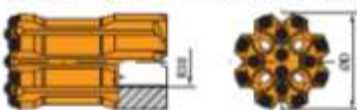

Button bit, Flat face, Type D62

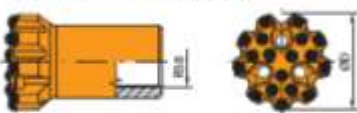

Button bit, Flat face, Retrac, Type D63



Diameter		Flushing holes (mm)		Buttons (mm)		Catalogue no.
		Side	Front	Gauge	Front	
mm	inch	No x Size	No x Size	No x Size	No x Size	
64	2 1/2	-	4 x 8	8 x 10	5 x 9	D60064R3805R
64	2 1/2	-	4 x 8	8 x 10	5 x 9	D60064R3805S
70	2 3/4	-	4 x 8	8 x 11	5 x 10	D60070R3805R
70	2 3/4	-	4 x 8	8 x 11	5 x 10	D60070R3805S
76	3	-	4 x 8	8 x 12	5 x 11	D60076R3805R
76	3	-	4 x 8	8 x 12	5 x 11	D60076R3805S
89	3 1/2	-	4 x 9	8 x 13	5 x 12	D60089R3805R
89	3 1/2	-	4 x 9	8 x 13	5 x 12	D60089R3805S
102	4	-	4 x 9	8 x 14	6 x 13	D60102R3805R
102	4	-	4 x 9	8 x 14	6 x 13	D60102R3805S
64	2 1/2	-	4 x 8	8 x 10	5 x 9	D61064R3805R
64	2 1/2	-	4 x 8	8 x 10	5 x 9	D61064R3805S
70	2 3/4	-	4 x 8	8 x 11	5 x 10	D61070R3805R
70	2 3/4	-	4 x 8	8 x 11	5 x 10	D61070R3805S
76	3	-	4 x 8	8 x 12	5 x 11	D61076R3805R
76	3	-	4 x 8	8 x 12	5 x 11	D61076R3805S
89	3 1/2	-	4 x 9	8 x 13	5 x 12	D61089R3805R
89	3 1/2	-	4 x 9	8 x 13	5 x 12	D61089R3805S
102	4	-	4 x 9	8 x 14	6 x 13	D61102R3805R
102	4	-	4 x 9	8 x 14	6 x 13	D61102R3805S
76	3	-	3 x 9	9 x 11	8 x 10	D62076R3805R
76	3	-	3 x 9	9 x 11	8 x 10	D62076R3805S
89	3 1/2	-	3 x 9	9 x 12	9 x 11	D62089R3805R
89	3 1/2	-	3 x 9	9 x 12	9 x 11	D62089R3805S
102	4	-	3 x 9	9 x 13	9 x 12	D62102R3805R
102	4	-	3 x 9	9 x 13	9 x 12	D62102R3805S
76	3	-	3 x 9	9 x 11	8 x 10	D63076R3805R
76	3	-	3 x 9	9 x 11	8 x 10	D63076R3805S
89	3 1/2	-	3 x 9	9 x 12	9 x 11	D63089R3805R
89	3 1/2	-	3 x 9	9 x 12	9 x 11	D63089R3805S
102	4	-	3 x 9	9 x 13	9 x 12	D63102R3805R
102	4	-	3 x 9	9 x 13	9 x 12	D63102R3805S

Button bit, Heavy Duty

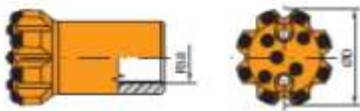

Button bit, Retrac, Heavy Duty

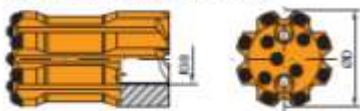

Diameter		Flushing holes (mm)		Buttons (mm)		Catalogue no.
		Side	Front	Gauge	Front	
mm	inch	No x Size	No x Size	No x Size	No x Size	
64	2 1/2	-	2 x 8	8 x 11	4 x 10	D62064R3815R
70	2 7/8	-	2 x 9	8 x 12	4 x 11	D62070R3815R
76	3	-	2 x 10	8 x 12	4 x 12	D62076R3815R
89	3 1/2	-	2 x 11	8 x 13	5 x 12	D62089R3815R
102	4	-	2 x 11	8 x 14	6 x 13	D62102R3815R
64	2 1/2	-	2 x 8	8 x 11	4 x 10	D63064R3815R
70	2 7/8	-	2 x 9	8 x 12	4 x 11	D63070R3815R
76	3	-	2 x 10	8 x 12	4 x 12	D63076R3815R
89	3 1/2	-	2 x 11	8 x 13	5 x 12	D63089R3815R
102	4	-	2 x 11	8 x 14	6 x 13	D63102R3815R

Reaming bit, Type D54

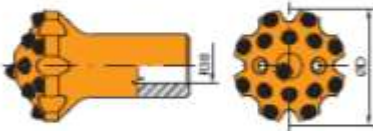

Diameter		Flushing holes (mm)		Buttons (mm)		Catalogue no.
		Side	Front	Gauge	Front	
mm	inch	No x Size	No x Size	No x Size	No x Size	
76	3	-	2 x 9	8 x 12	7 x 11	D54076R3805R
76	3	-	2 x 9	8 x 12	7 x 11	D54076R3805S
89	3 1/2	-	2 x 9	8 x 12	7 x 12	D54089R3805R
89	3 1/2	-	2 x 9	8 x 12	7 x 12	D54089R3805S
102	4	-	2 x 10	8 x 13	9 x 13	D54102R3805R
102	4	-	2 x 10	8 x 13	9 x 13	D54102R3805S
115	4 1/2	-	2 x 11	8 x 14	9 x 13	D54115R3805R
115	4 1/2	-	2 x 11	8 x 14	9 x 13	D54115R3805S
127	5	-	2 x 11	8 x 15	9 x 14	D54127R3805R
127	5	-	2 x 11	8 x 15	9 x 14	D54127R3805S

Cross bit, Type D42

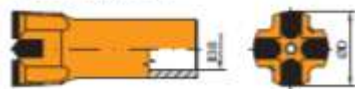

Cross bit, Retrac, Type D52

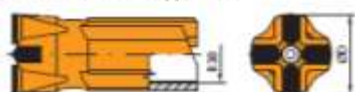

Diameter		Flushing holes (mm)		Catalogue no.
		Side	Front	
mm	inch	No x Size	No x Size	
64	2 1/2	2 x 7	1 x 8	D42064R3802
76	3	2 x 8	1 x 10	D42076R3802
89	3 1/2	2 x 9	1 x 10	D42089R3802
76	1 1/2	2 x 8	1 x 10	D52076R3802
89	1 1/2	2 x 9	1 x 10	D52089R3802
102	2	2 x 9	1 x 11	D52102R3802

Travaux souterrains

R38

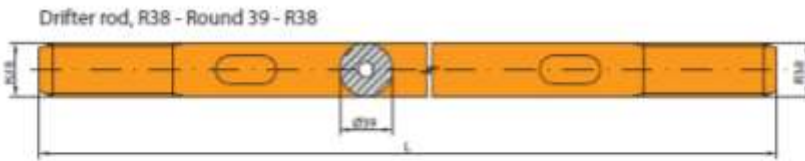

Hex		Threads	Dimensions			Catalogue no.
mm	inch		Length			
			mm	ft	inch	
39	1 1/2	R38/R38	915	3	-	23212091
39	1 1/2	R38/R38	1000	3	3/4	23212100
39	1 1/2	R38/R38	1220	4	-	23212122
39	1 1/2	R38/R38	1525	5	-	23212152
39	1 1/2	R38/R38	1830	6	-	23212183
39	1 1/2	R38/R38	2435	8	-	23212243
39	1 1/2	R38/R38	3050	10	-	23212305
39	1 1/2	R38/R38	3660	12	-	23212366
39	1 1/2	R38/R38	4305	14	1 1/2	23212430
39	1 1/2	R38/R38	4915	16	-	23212491

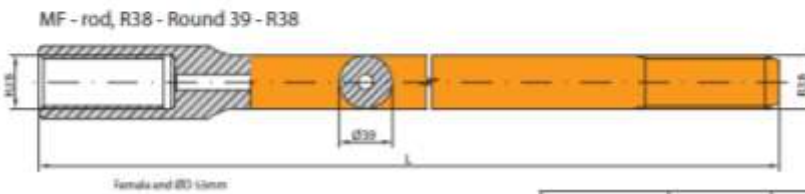

Hex		Threads	Dimensions			Catalogue no.
mm	inch		Length			
			mm	ft	inch	
39	1 1/2	R38/R38	915	3	-	26213091
39	1 1/2	R38/R38	1000	3	3/4	26213100
39	1 1/2	R38/R38	1220	4	-	26213122
39	1 1/2	R38/R38	1525	5	-	26213152
39	1 1/2	R38/R38	1830	6	-	26213183
39	1 1/2	R38/R38	2435	8	-	26213243
39	1 1/2	R38/R38	3050	10	-	26213305
39	1 1/2	R38/R38	3660	12	-	26213366
39	1 1/2	R38/R38	4305	14	1 1/2	26213430
39	1 1/2	R38/R38	4915	16	-	26213491

Travaux souterrains

R38

Coupling sleeve R38

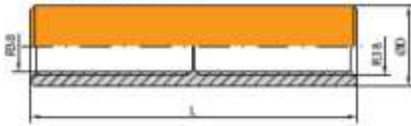

Diameter		Threads	Length		Catalogue no.
mm	inch		mm	inch	
55	2 1/4	R38/R38	160	6 1/4	3921200

Coupling sleeve

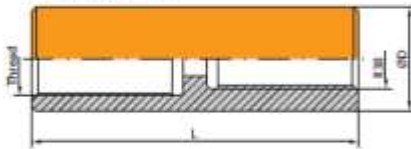

Diameter		Threads	Length		Catalogue no.
mm	inch		mm	inch	
55	2 1/4	T38/R38	190	7 1/2	3927201
62	2 1/2	T45/R38	190	7 1/2	3937201

Bit adapter coupling

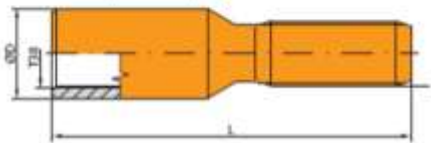

Diameter		Threads	Length		Catalogue no.
mm	inch		mm	inch	
55	2 1/4	T38/R38	200	7 7/8	3927206

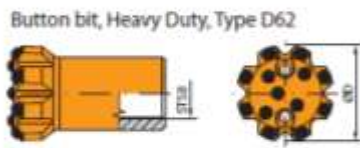
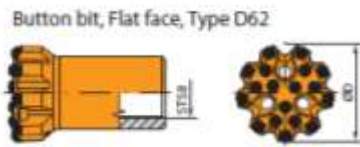
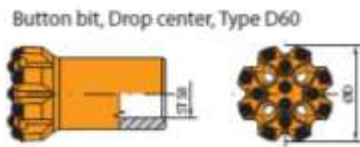

Diameter		Flushing holes (mm)		Buttons (mm)		Catalogue no.
		Side	Front	Gauge	Front	
mm	inch	No x Size	No x Size	No x Size	No x Size	
89	3 1/2	-	4 x 10	8 x 13	5 x 12	D60089ST5805R
89	3 1/2	-	4 x 10	8 x 13	5 x 12	D60089ST5805S
102	4	-	4 x 11	8 x 14	6 x 13	D60102ST5805R
102	4	-	4 x 11	8 x 14	6 x 13	D60102ST5805S
115	4 1/2	-	4 x 11	8 x 16	6 x 15	D60115ST5805R
115	4 1/2	-	4 x 11	8 x 16	6 x 15	D60115ST5805S
127	5	-	4 x 12	8 x 16	8 x 15	D60127ST5805R
127	5	-	4 x 12	8 x 16	8 x 15	D60127ST5805S
89	3 1/2	-	3 x 11	9 x 12	9 x 11	D62089ST5805R
89	3 1/2	-	3 x 11	9 x 12	9 x 11	D62089ST5805S
102	4	-	3 x 12	9 x 13	9 x 12	D62102ST5805R
102	4	-	3 x 12	9 x 13	9 x 12	D62102ST5805S
115	4 1/2	-	3 x 12	9 x 14	10 x 12	D62115ST5805R
115	4 1/2	-	3 x 12	9 x 14	10 x 12	D62115ST5805S
127	5	-	3 x 13	9 x 16	10 x 14	D62127ST5805R
127	5	-	3 x 13	9 x 16	10 x 14	D62127ST5805S
89	3 1/2	-	2 x 14	8 x 14	5 x 12	D62089ST5815R
102	4	-	2 x 14	8 x 15	6 x 13	D62102ST5815R
115	4 1/2	-	2 x 15	8 x 16	7 x 14	D62115ST5815R
127	5	-	2 x 15	8 x 17	8 x 15	D62127ST5815R

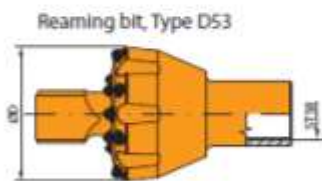

Diameter		Flushing holes (mm)		Buttons (mm)		Catalogue no.
		Side	Front	Gauge	Front	
mm	inch	No x Size	No x Size	No x Size	No x Size	
152	6	3 x 14	-	8 x 15	7 x 15	D53152ST5805R

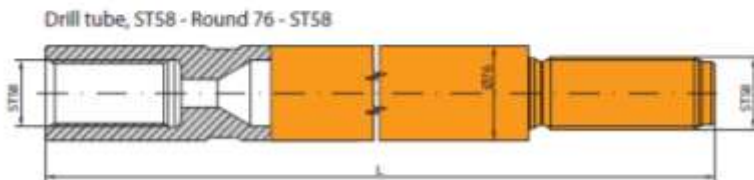

Hex		Threads	Dimensions			Catalogue no.
			Length			
mm	inch		mm	ft	inch	
76	3	ST58/ST58	1525	5	-	12R76ST58ST58152
76	3	ST58/ST58	1830	6	-	12R76ST58ST58183

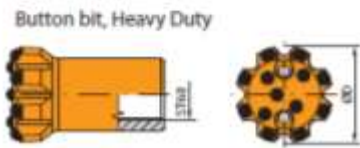
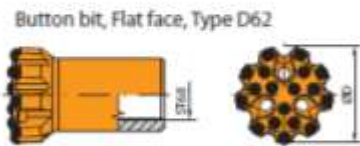
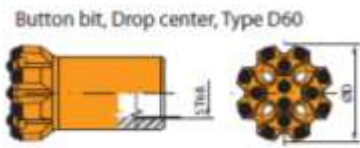

Diameter		Flushing holes (mm)		Buttons (mm)		Catalogue no.
		Side	Front	Gauge	Front	
mm	inch	No x Size	No x Size	No x Size	No x Size	
102	4	-	4 x 11	8 x 14	6 x 13	D60102ST6805R
102	4	-	4 x 11	8 x 14	6 x 13	D60102ST6805S
115	4 1/2	-	4 x 11	8 x 16	6 x 15	D60115ST6805R
115	4 1/2	-	4 x 11	8 x 16	6 x 15	D60115ST6805S
127	5	-	4 x 12	8 x 16	8 x 15	D60127ST6805R
127	5	-	4 x 12	8 x 16	8 x 15	D60127ST6805S
152	6	-	4 x 12	8 x 17	8 x 16	D60152ST6805R
152	6	-	4 x 12	8 x 17	8 x 16	D60152ST6805S
102	4	-	3 x 12	9 x 13	9 x 12	D62102ST6805R
102	4	-	3 x 12	9 x 13	9 x 12	D62102ST6805S
115	4 1/2	-	3 x 12	9 x 14	10 x 12	D62115ST6805R
115	4 1/2	-	3 x 12	9 x 14	10 x 12	D62115ST6805S
127	5	-	3 x 13	9 x 16	10 x 14	D62127ST6805R
127	5	-	3 x 13	9 x 16	10 x 14	D62127ST6805S
152	6	-	3 x 13	9 x 16	10 x 15	D62152ST6805R
152	6	-	3 x 13	9 x 16	10 x 15	D62152ST6805S
102	4	-	2 x 14	8 x 15	6 x 13	D62102ST6815R
115	4 1/2	-	2 x 15	8 x 16	7 x 14	D62115ST6815R
127	5	-	2 x 15	8 x 17	8 x 15	D62127ST6815R
152	6	-	2 x 15	8 x 17	8 x 16	D62152ST6815R

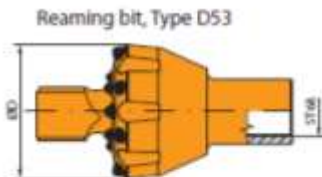

Diameter		Flushing holes (mm)		Buttons (mm)		Catalogue no.
		Side	Front	Gauge	Front	
mm	inch	No x Size	No x Size	No x Size	No x Size	
152	6	3 x 15	-	8 x 16	7 x 16	D53152ST6805R

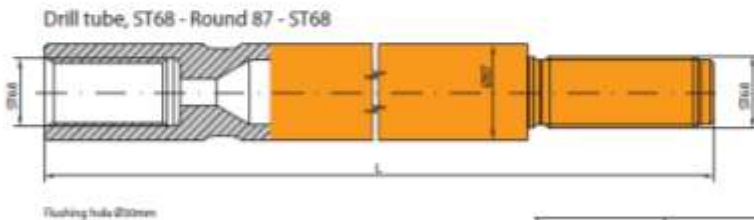

Hex		Threads	Dimensions			Catalogue no.
mm	inch		Length			
			mm	ft	inch	
87	3 1/2	ST68/ST68	1525	5	-	12R87ST68ST68152
87	3 1/2	ST68/ST68	1830	6	-	12R87ST68ST68183



Button bit – DROP CENTER

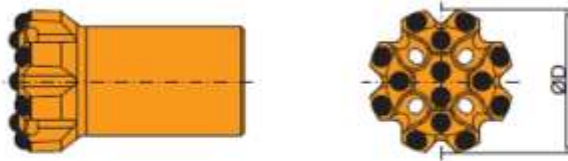

Diameter		Flushing holes		Buttons (mm)		Catalogue no.
mm	inch	Side No x Size	Front No x Size	Gauge No x Size	Front No x Size	
64	2 ½	-	4x8	8x10	5x9	B50064T3805R
64	2 ½	-	4x8	8x10	5x9	B50064T3805S
70	2 ¾	-	4x8	8x11	5x10	B50070T3805R
70	2 ¾	-	4x8	8x11	5x10	B50070T3805S
76	3	-	4x8	8x12	5x11	B50076T3805R
76	3	-	4x8	8x12	5x11	B50076T3805S
89	3 ½	-	4x9	8x13	5x12	B50089T3805R
89	3 ½	-	4x9	8x13	5x12	B50089T3805S
102	4	-	4x9	8x14	6x13	B50102T3805R
102	4	-	4x9	8x14	6x13	B50102T3805S

R – spherical (Gauge angle (35°))

S – ballistic (Gauge angle (40°))

Button bit – DROP CENTER – RETRAC



Diameter		Flushing holes		Buttons (mm)		Catalogue no.
mm	inch	Side No x Size	Front No x Size	Gauge No x Size	Front No x Size	
64	2 ½	-	4x8	8x10	5x9	B51064T3805R
64	2 ½	-	4x8	8x10	5x9	B51064T3805S
70	2 ¾	-	4x8	8x11	5x10	B51070T3805R
70	2 ¾	-	4x8	8x11	5x10	B51070T3805S
76	3	-	4x8	8x12	5x11	B51076T3805R
76	3	-	4x8	8x12	5x11	B51076T3805S
89	3 ½	-	4x9	8x13	5x12	B51089T3805R
89	3 ½	-	4x9	8x13	5x12	B51089T3805S
102	4	-	4x9	8x14	6x13	B51102T3805R
102	4	-	4x9	8x14	6x13	B51102T3805S

R – spherical (Gauge angle (35°))

S – ballistic (Gauge angle (40°))

Button bit – FLAT FACE



Diameter		Flushing holes		Buttons (mm)		Catalogue no.
mm	inch	Side No x Size	Front No x Size	Gauge No x Size	Front No x Size	
64	2 ½	-	3x8	9x10	8x8	B52064T3805R
64	2 ½	-	3x8	9x10	8x8	B52064T3805S
76	3	-	3x9	9x12	8x10	B52076T3805R
76	3	-	3x9	9x12	8x10	B52076T3805S
89	3 ½	-	3x10	9x13	9x11	B52089T3805R
89	3 ½	-	3x10	9x13	9x11	B52089T3805S
102	4	-	3x10	9x14	9x12	B52102T3805R
102	4	-	3x10	9x14	9x12	B52102T3805S

R – spherical (Gauge angle (35°))

S – ballistic (Gauge angle (40°))

Button bit – FLAT FACE – RETRAC



Diameter		Flushing holes		Buttons (mm)		Catalogue no.
mm	inch	Side No x Size	Front No x Size	Gauge No x Size	Front No x Size	
64	2 ½	-	3x8	9x10	8x8	B53064T3805R
64	2 ½	-	3x8	9x10	8x8	B53064T3805S
76	3	-	3x9	9x12	8x10	B53076T3805R
76	3	-	3x9	9x12	8x10	B53076T3805S
89	3 ½	-	3x10	9x13	9x11	B53089T3805R
89	3 ½	-	3x10	9x13	9x11	B53089T3805S
102	4	-	3x10	9x14	9x12	B53102T3805R
102	4	-	3x10	9x14	9x12	B53102T3805S

R – spherical (Gauge angle (35°))

S – ballistic (Gauge angle (40°))

Button bit – FLAT FACE – Heavy Duty

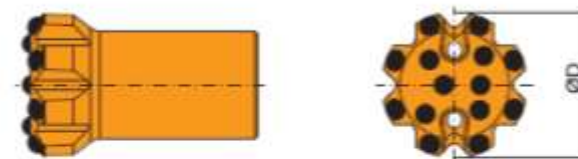

Diameter		Flushing holes		Buttons (mm)		Catalogue no.
mm	inch	Side No x Size	Front No x Size	Gauge No x Size	Front No x Size	
64	2 ½	-	2x9	8x11	4x10	B52064T3815R
70	2 ¾	-	2x10	8x12	4x11	B52070T3815R
76	3	-	2x11	8x13	4x12	B52076T3815R
89	3 ½	-	2x12	8x14	5x13	B52089T3815R
102	4	-	2x12	8x15	6x14	B52102T3815R

R – spherical (Gauge angle (35°))

Button bit – FLAT FACE – Heavy Duty



Diameter		Flushing holes		Buttons (mm)		Catalogue no.
mm	inch	Side No x Size	Front No x Size	Gauge No x Size	Front No x Size	
64	2 ½	-	2x9	8x11	4x10	B53064T3815R
70	2 ¾	-	2x10	8x12	4x11	B53070T3815R
76	3	-	2x11	8x13	4x12	B53076T3815R
89	3 ½	-	2x12	8x14	5x13	B53089T3815R
102	4	-	2x12	8x15	6x14	B53102T3815R

R – spherical (Gauge angle (35°))

Button bit

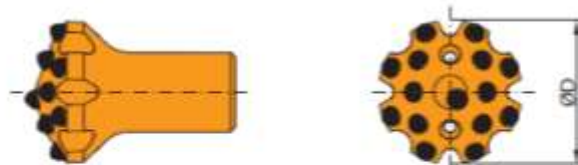

Diameter		Flushing holes		Buttons (mm)		Catalogue no.
mm	inch	Side No x Size	Front No x Size	Gauge No x Size	Front No x Size	
70	2 ¾	-	2x8	8x11	5x10	B54070T3805R
76	3	-	2x9	8x12	6x11	B54076T3805R
89	3 ½	-	2x9	8x13	6x13	B54089T3805R
102	4	-	2x10	8x13	7x13	B54102T3805R

R – spherical (Front angle (20°), Gauge angle (40°))

Reaming button bit



Diameter		Flushing holes		Buttons (mm)		Catalogue no.
mm	inch	Side No x Size	Front No x Size	Gauge No x Size	Front No x Size	
115	4 ½	1x7	3x7	9x13	5x13, 3x12	B54115T3815R
127	5	1x7,5	3x7,5	9x14	5x14, 4x13	B54127T3815R

R – spherical (Gauge angle (35°))

Cross X-type bit



Diameter		Flushing holes		Buttons (mm)		Catalogue no.
mm	inch	Side No x Size	Front No x Size	Gauge No x Size	Front No x Size	
64	2 ½	2x7	1x8	-	-	B48064T380B2
76	3	2x8	1x10	-	-	B48076T380B2
89	3 ½	2x9	1x10	-	-	B48089T380B2

Cross X-type bit – RETRAC

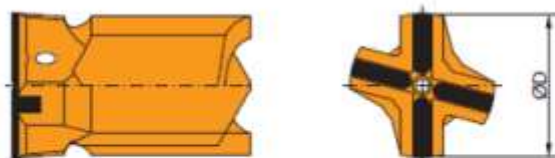

Diameter		Flushing holes		Buttons (mm)		Catalogue no.
mm	inch	Side No x Size	Front No x Size	Gauge No x Size	Front No x Size	
76	3	2x7	1x8	-	-	B49076T380B2
89	3 ½	2x8	1x10	-	-	B49089T380B2
102	4	2x9	1x10	-	-	B49102T380B2

Hex rods

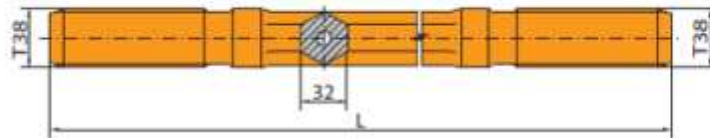

Hex		Threads	Length			Catalogue no.
mm	inch		mm	ft	inch	
32	1 ¼	T38/T38	915	3	-	2122209
32	1 ¼	T38/T38	1220	4	-	21222122
32	1 ¼	T38/T38	1525	5	-	21222152
32	1 ¼	T38/T38	1830	6	-	21222183
32	1 ¼	T38/T38	2165	7	-	21222216
32	1 ¼	T38/T38	2435	8	-	21222243
32	1 ¼	T38/T38	3050	10	-	2122230
32	1 ¼	T38/T38	3660	12	-	2122236
32	1 ¼	T38/T38	4265	14	-	21222427
32	1 ¼	T38/T38	4915	16	-	21222491

Flushing hole ϕ 16 mm

Extension rods

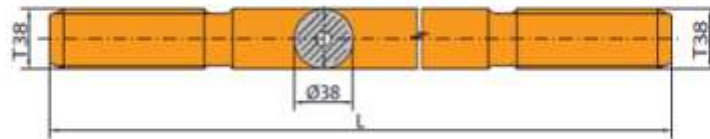

Diameter		Threads	Length			Catalogue no.
mm	inch		mm	ft	inch	
38	1 ½	T38/T38	915	3	-	2322209
38	1 ½	T38/T38	1220	4	-	2322212
38	1 ½	T38/T38	1525	5	-	23222152
38	1 ½	T38/T38	1830	6	-	2322218
38	1 ½	T38/T38	2165	7	-	23222216
38	1 ½	T38/T38	2435	8	-	23222243
38	1 ½	T38/T38	3050	10	-	2322230
38	1 ½	T38/T38	3660	12	-	2322236
38	1 ½	T38/T38	4265	14	-	23222427
38	1 ½	T38/T38	4915	16	-	23222491
38	1 ½	T38/T38	5490	18	-	23222549

Flushing hole ϕ 14,5 mm

Speed rods / M-F rods

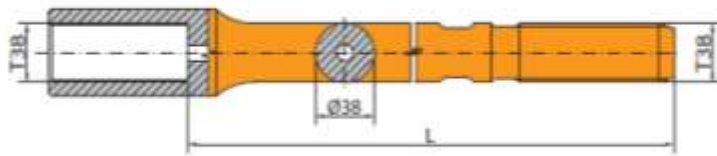

Diameter		Threads	Length			Catalogue no.
mm	inch		mm	ft	inch	
38	1 ½	T38/T38	915	3	-	2622309
38	1 ½	T38/T38	1220	4	-	2622312
38	1 ½	T38/T38	1525	5	-	26223152
38	1 ½	T38/T38	1830	6	-	2622318
38	1 ½	T38/T38	2165	7	-	26223216
38	1 ½	T38/T38	2435	8	-	26223243
38	1 ½	T38/T38	3050	10	-	2622330
38	1 ½	T38/T38	3660	12	-	2622336
38	1 ½	T38/T38	4265	14	-	2622342
38	1 ½	T38/T38	4915	16	-	26223491
38	1 ½	T38/T38	5490	18	-	26223549

Flushing hole ϕ 14,5 mm, Female end ϕ 55 mm

Guide tube rods

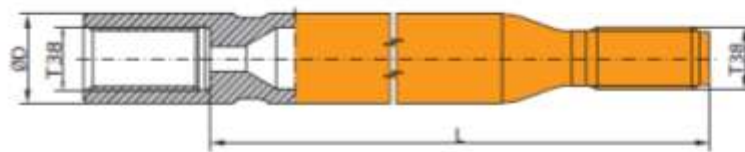

Diameter		Threads	Length			Catalogue no.
mm	inch		mm	ft	inch	
56	2 ¼	T38/T38	1525	5	-	1256T38T38152
56	2 ¼	T38/T38	1830	6	-	1256T38T38183
56	2 ¼	T38/T38	3050	10	-	1256T38T38305
56	2 ¼	T38/T38	3660	12	-	1256T38T38366
64	2 ½	T38/T38	3660	12	-	1264T38T38366

Guide tube rods

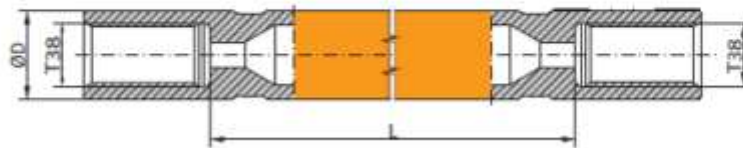

Diameter		Threads	Length			Catalogue no.
mm	inch		mm	ft	inch	
56	2 ¼	T38/T38	1525	5	-	1356T38T38152
56	2 ¼	T38/T38	1830	6	-	1356T38T38183
56	2 ¼	T38/T38	3050	10	-	1356T38T38305
56	2 ¼	T38/T38	3660	12	-	1356T38T38366
64	2 ½	T38/T38	3660	12	-	1364T38T38366

Coupling sleeve

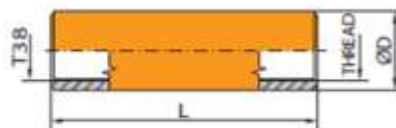

Diameter		Threads	Length		Catalogue no.
mm	inch		mm	inch	
55	2 ¼	T38/R32	175	7	3947201
55	2 ¼	T38/T38	180	7 ½	3922200

Full bridge

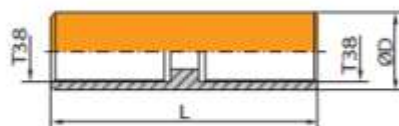

Diameter		Threads	Length		Catalogue no.
mm	inch		mm	inch	
55	2 ¼	T38/T38	210	8 ¼	3922201

M-F adapters

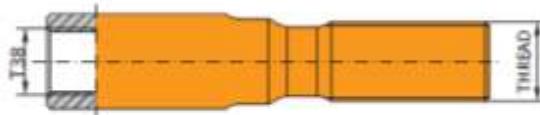

Threads female/male	Length		Catalogue no.
	mm	inch	
T38/R32	240	9 1/2	39472061
T38/T45	275	10 3/4	3922306

M-M adapters



Threads male/male	Length		Catalogue no.
	mm	inch	
T38/T38	220	8 3/4	3838T38T3800

Button bit – DROP CENTER



Diameter		Flushing holes		Buttons (mm)		Catalogue no.
mm	inch	Side No x Size	Front No x Size	Gauge No x Size	Front No x Size	
70	2 ¾	-	4x8	8x11	5x10	B50070T4505R
70	2 ¾	-	4x8	8x11	5x10	B50070T4505S
76	3	-	4x8	8x12	5x11	B50076T4505R
76	3	-	4x8	8x12	5x11	B50076T4505S
89	3 ½	-	4x9	8x13	5x12	B50089T4505R
89	3 ½	-	4x9	8x13	5x12	B50089T4505S
102	4	-	4x9	8x14	6x13	B50102T4505R
102	4	-	4x9	8x14	6x13	B50102T4505S
115	4 ½	-	4x9	8x15	8x14	B50115T4505R
115	4 ½	-	4x9	8x15	8x14	B50115T4505S
127	5	-	4x10	8x16	8x15	B50127T4505R
127	5	-	4x10	8x16	8x15	B50127T4505S

R – spherical (Gauge angle (35°))

S – ballistic (Gauge angle (40°))

Button bit – DROP CENTER – RETRAC

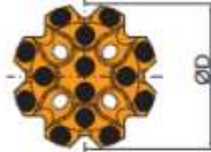
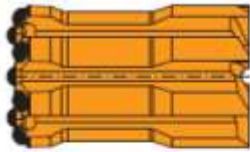

Diameter		Flushing holes		Buttons (mm)		Catalogue no.
mm	inch	Side No x Size	Front No x Size	Gauge No x Size	Front No x Size	
70	2 ¾	-	4x8	8x11	5x10	B51070T4505R
70	2 ¾	-	4x8	8x11	5x10	B51070T4505S
76	3	-	4x8	8x12	5x11	B51076T4505R
76	3	-	4x8	8x12	5x11	B51076T4505S
89	3 ½	-	4x9	8x13	5x12	B51089T4505R
89	3 ½	-	4x9	8x13	5x12	B51089T4505S
102	4	-	4x9	8x14	6x13	B51102T4505R
102	4	-	4x9	8x14	6x13	B51102T4505S
115	4 ½	-	4x9	8x15	8x14	B51115T4505R
115	4 ½	-	4x9	8x15	8x14	B51115T4505S
127	5	-	4x10	8x16	8x15	B51127T4505R
127	5	-	4x10	8x16	8x15	B51127T4505S

R – spherical (Gauge angle (35°))

S – ballistic (Gauge angle (40°))

Button bit – FLAT FACE

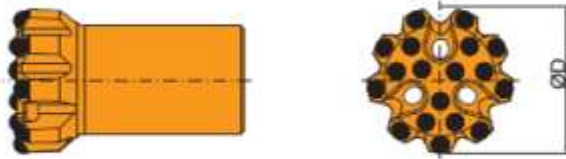

Diameter		Flushing holes		Buttons (mm)		Catalogue no.
mm	inch	Side No x Size	Front No x Size	Gauge No x Size	Front No x Size	
76	3	-	3x9	9x12	8x10	B52076T4505R
76	3	-	3x9	9x12	8x10	B52076T4505S
80	3 1/2	-	3x9	9x12	8x10	B52080T4505R
80	3 1/2	-	3x9	9x12	8x10	B52080T4505S
89	3 1/2	-	3x10	9x13	9x11	B52089T4505R
89	3 1/2	-	3x10	9x13	9x11	B52089T4505S
102	4	-	3x10	9x14	9x12	B52102T4505R
102	4	-	3x10	9x14	9x12	B52102T4505S
115	4 1/2	-	3x10	9x15	10x13	B52115T4505R
115	4 1/2	-	3x10	9x15	10x13	B52115T4505S

R – spherical (Gauge angle (35°))

S – ballistic (Gauge angle (40°))

Button bit – FLAT FACE – RETRAC

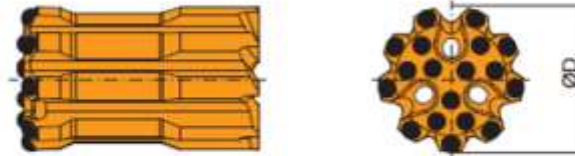

Diameter		Flushing holes		Buttons (mm)		Catalogue no.
mm	inch	Side No x Size	Front No x Size	Gauge No x Size	Front No x Size	
76	3	-	3x9	9x12	8x10	B53076T4505R
76	3	-	3x9	9x12	8x10	B53076T4505S
80	3 ½	-	3x9	9x12	8x10	B53080T4505R
80	3 ½	-	3x9	9x12	8x10	B53080T4505S
89	3 ½	-	3x10	9x13	9x11	B53089T4505R
89	3 ½	-	3x10	9x13	9x11	B53089T4505S
102	4	-	3x10	9x14	9x12	B53102T4505R
102	4	-	3x10	9x14	9x12	B53102T4505S
115	4 ½	-	3x10	9x15	10x13	B53115T4505R
115	4 ½	-	3x10	9x15	10x13	B53115T4505S

R – spherical (Gauge angle (35°))

S – ballistic (Gauge angle (40°))

Button bit – FLAT FACE – Heavy Duty

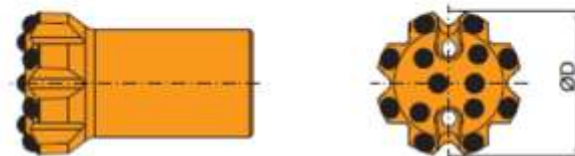

Diameter		Flushing holes		Buttons (mm)		Catalogue no.
mm	inch	Side No x Size	Front No x Size	Gauge No x Size	Front No x Size	
70	2 ¾	-	2x9	8x12	4x11	B52070T4515R
76	3	-	2x10	8x13	4x12	B52076T4515R
80	3 ½	-	2x11	8x13	5x12	B52080T4515R
89	3 ½	-	2x11	8x14	5x13	B52089T4515R
102	4	-	2x11	8x15	6x14	B52102T4515R
115	4 ½	-	2x12	8x16	7x15	B52115T4515R

R – spherical (Gauge angle (35°))

Button bit – FLAT FACE – RETRAC – Heavy Duty



Diameter		Flushing holes		Buttons (mm)		Catalogue no.
mm	inch	Side No x Size	Front No x Size	Gauge No x Size	Front No x Size	
70	2 ¾	-	2x9	8x12	4x11	B53070T4515R
76	3	-	2x10	8x13	4x12	B53076T4515R
80	3 ½ ₂	-	2x11	8x13	5x12	B53080T4515R
89	3 ½	-	2x11	8x14	5x13	B53089T4515R
102	4	-	2x11	8x15	6x14	B53102T4515R
115	4 ½	-	2x12	8x16	7x15	B53115T4515R

R – spherical (Gauge angle (35°))

Button bit

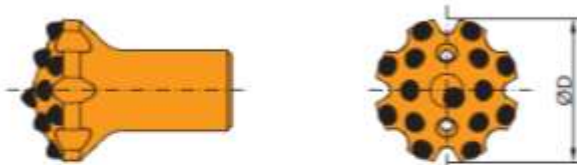

Diameter		Flushing holes		Buttons (mm)		Catalogue no.
mm	inch	Side No x Size	Front No x Size	Gauge No x Size	Front No x Size	
76	3	-	2x10	8x12	6x11	B54076T4505R
89	3 ½	-	2x10	8x13	6x13	B54089T4505R
102	4	-	2x11	8x13	7x13	B54102T4505R
115	4 ½	-	2x12	8x14	8x13	B54115T4505R

R – spherical (Front angle (20°), Gauge angle (40°))

Reaming button bit

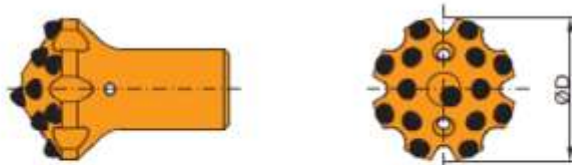

Diameter		Flushing holes		Buttons (mm)		Catalogue no.
mm	inch	Side No x Size	Front No x Size	Gauge No x Size	Front No x Size	
115	4 ½	1x8	3x8	9x13	5x13, 3x12	B54115T4515R
127	5	1x9	3x9	9x14	5x14, 4x13	B54127T4515R
152	6	1x10	3x10	9x15	11x15	B54152T4515R

R – spherical (Gauge angle (35°))

Cross X-type bit



Diameter		Flushing holes		Buttons (mm)		Catalogue no.
mm	inch	Side No x Size	Front No x Size	Gauge No x Size	Front No x Size	
76	3	2x9	1x10	-	-	B48076T450B2
89	3 ½	2x10	1x10	-	-	B48089T450B2
102	4	2x10	1x11	-	-	B48102T450B2

Cross X-type bit – RETRAC

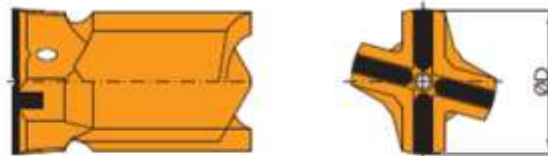

Diameter		Flushing holes		Buttons (mm)		Catalogue no.
mm	inch	Side No x Size	Front No x Size	Gauge No x Size	Front No x Size	
76	3	2x9	1x10	-	-	B49076T450B2
89	3 ½	2x10	1x10	-	-	B49089T450B2
102	4	2x10	1x11	-	-	B49102T450B2

Extension rods diameter 38mm

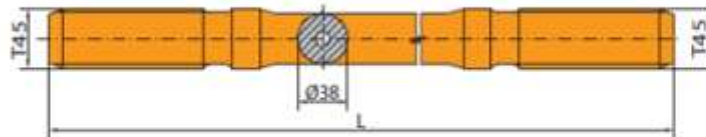

Diameter		Threads	Length			Catalogue no.
mm	inch		mm	ft	inch	
38	1 ½	T45/T45	915	3	-	2332309
38	1 ½	T45/T45	1220	4	-	23323122
38	1 ½	T45/T45	1525	5	-	23323152
38	1 ½	T45/T45	1830	6	-	23323183
38	1 ½	T45/T45	2165	7	-	23323216
38	1 ½	T45/T45	2435	8	-	23323243
38	1 ½	T45/T45	3050	10	-	2332330
38	1 ½	T45/T45	3660	12	-	2332336
38	1 ½	T45/T45	4265	14	-	23323427
38	1 ½	T45/T45	4915	16	-	23323491

Flushing hole ϕ 14,5 mm

Extension rods diameter 46mm

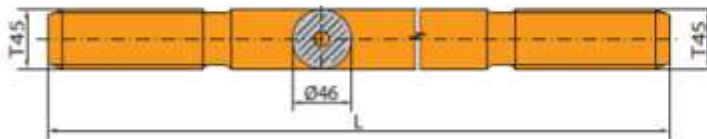

Diameter		Threads	Length			Catalogue no.
mm	inch		mm	ft	inch	
46	1 3/4	T45/T45	915	3	-	1832309
46	1 3/4	T45/T45	1220	4	-	18323122
46	1 3/4	T45/T45	1525	5	-	18323152
46	1 3/4	T45/T45	1830	6	-	1832318
46	1 3/4	T45/T45	2165	7	-	18323216
46	1 3/4	T45/T45	2435	8	-	18323243
46	1 3/4	T45/T45	3050	10	-	18323305
46	1 3/4	T45/T45	3660	12	-	1832336
46	1 3/4	T45/T45	4265	14	-	18323427
46	1 3/4	T45/T45	4915	16	-	18323491
46	1 3/4	T45/T45	6100	20	-	18323610
46	1 3/4	T45/T45	7200	24	-	18323720

Flushing hole ϕ 17 mm

Speed rods / M-F rods

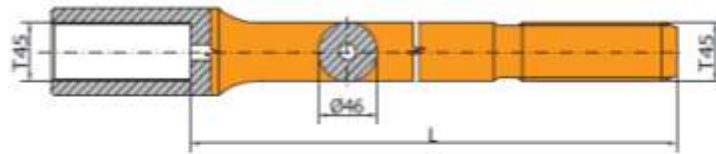

Diameter		Threads	Length			Catalogue no.
mm	inch		mm	ft	inch	
46	1 3/4	T45/T45	1525	5	-	26626152
46	1 3/4	T45/T45	1830	6	-	26626181
46	1 3/4	T45/T45	2165	7	-	26626216
46	1 3/4	T45/T45	2435	8	-	26626243
46	1 3/4	T45/T45	3050	10	-	2662630
46	1 3/4	T45/T45	3660	12	-	2662636
46	1 3/4	T45/T45	4265	14	-	2662642
46	1 3/4	T45/T45	4915	16	-	26626491
46	1 3/4	T45/T45	6100	20	-	26626610
46	1 3/4	T45/T45	7200	24	-	26626720

Flushing hole ϕ 17 mm, Female end ϕ 67 mm

Guide tube rods

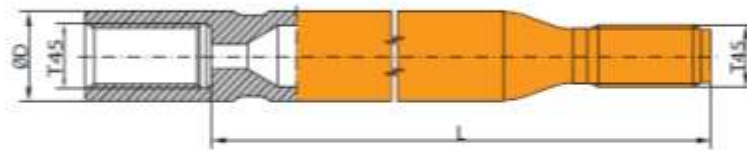

Diameter		Threads	Length			Catalogue no.
mm	inch		mm	ft	inch	
64	2 1/2	T45/T45	1830	6	-	1263T45T45183
64	2 1/2	T45/T45	3660	12	-	1263T45T45366
64	2 1/2	T45/T45	4265	14	-	1263T45T45426
76	3	T45/T45	3660	12	-	1276T45T45366
76	3	T45/T45	4265	14	-	1276T45T45426

Guide tube rods

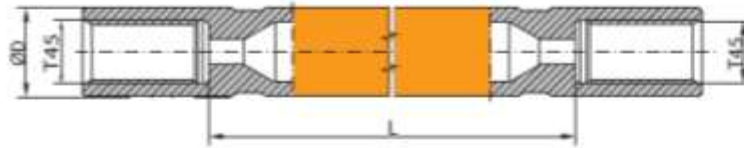

Diameter		Threads	Length			Catalogue no.
mm	inch		mm	ft	inch	
64	2 ½	T45/T45	1830	6	-	1363T45T45183
64	2 ½	T45/T45	3660	12	-	1363T45T45366
64	2 ½	T45/T45	4265	14	-	1363T45T45426
76	3	T45/T45	3660	12	-	1376T45T45366
76	3	T45/T45	4265	14	-	1376T45T45426

Coupling sleeve

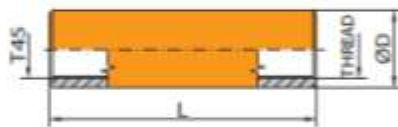

Diameter		Threads	Length		Catalogue no.
mm	inch		mm	inch	
64	2 ½	T45/T38	180	7 ½/32	3922300
64	2 ½	T45/T45	180	7 ½/32	3932300

Full bridge

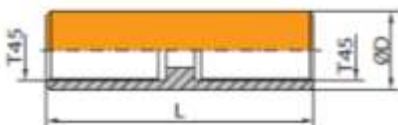

Diameter		Threads	Length		Catalogue no.
mm	inch		mm	inch	
64	2 ½	T45/T45	210	8 ¼	3932301

M-F adapters

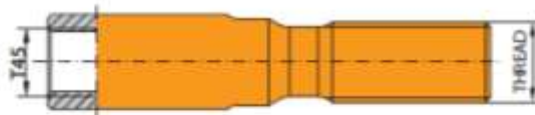

Threads female/male	Length		Catalogue no.
	mm	inch	
T45/T38	265	10 1/2	3932206
T45/T51	275	10 3/4	39523065

M-M adapters



Threads male/male	Length		Catalogue no.
	mm	inch	
T45/T45	220	8 5/8	3845T45T4500

Button bit – DROP CENTER

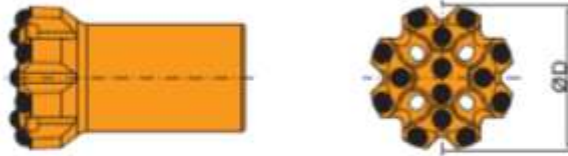

Diameter		Flushing holes		Buttons (mm)		Catalogue no.
mm	inch	Side No x Size	Front No x Size	Gauge No x Size	Front No x Size	
89	3 ½	-	4x9	8x13	5x12	B50089T5105R
89	3 ½	-	4x9	8x13	5x12	B50089T5105S
102	4	-	4x10	8x14	6x13	B50102T5105R
102	4	-	4x10	8x14	6x13	B50102T5105S
115	4 ½	-	4x11	8x15	6x14	B50115T5105R
115	4 ½	-	4x11	8x15	6x14	B50115T5105S
127	5	-	4x11	8x16	8x15	B50127T5105R
127	5	-	4x11	8x16	8x15	B50127T5105S
152	6	-	4x12	8x17	4x16, 4x15	B50152T5105R
152	6	-	4x12	8x17	4x16, 4x15	B50152T5105S

R – spherical (Gauge angle (35°))

S – ballistic (Gauge angle (40°))

Button bit – DROP CENTER – RETRAC



Diameter		Flushing holes		Buttons (mm)		Catalogue no.
mm	inch	Side No x Size	Front No x Size	Gauge No x Size	Front No x Size	
89	3 ½	-	4x9	8x13	5x12	B51089T5105R
89	3 ½	-	4x9	8x13	5x12	B51089T5105S
102	4	-	4x10	8x14	6x13	B51102T5105R
102	4	-	4x10	8x14	6x13	B51102T5105S
115	4 ½	-	4x11	8x15	6x14	B51115T5105R
115	4 ½	-	4x11	8x15	6x14	B51115T5105S
127	5	-	4x11	8x16	8x15	B51127T5105R
127	5	-	4x11	8x16	8x15	B51127T5105S
152	6	-	4x12	8x17	4x16, 4x15	B51152T5105R
152	6	-	4x12	8x17	4x16, 4x15	B51152T5105S

R – spherical (Gauge angle (35°))

S – ballistic (Gauge angle (40°))

Button bit – FLAT FACE

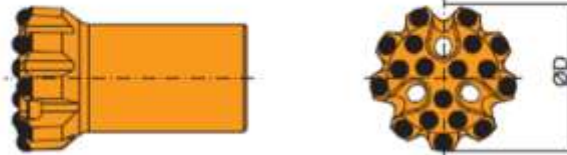

Diameter		Flushing holes		Buttons (mm)		Catalogue no.
mm	inch	Side No x Size	Front No x Size	Gauge No x Size	Front No x Size	
80	3 1/2	-	3x10	9x12	8x10	B52080T5105R
80	3 1/2	-	3x10	9x12	8x10	B52080T5105S
89	3 1/2	-	3x11	9x13	9x11	B52089T5105R
89	3 1/2	-	3x11	9x13	9x11	B52089T5105S
102	4	-	3x12	9x14	9x12	B52102T5105R
102	4	-	3x12	9x14	9x12	B52102T5105S
115	4 1/2	-	3x12	9x15	10x13	B52115T5105R
115	4 1/2	-	3x12	9x15	10x13	B52115T5105S
127	5	-	3x13	9x16	10x14	B52127T5105R
127	5	-	3x13	9x16	10x14	B52127T5105S
152	6	-	3x14	9x17	10x15	B52152T5105R
152	6	-	3x14	9x17	10x15	B52152T5105S

R – spherical (Gauge angle (35°))

S – ballistic (Gauge angle (40°))

Button bit – FLAT FACE – RETRAC



Diameter		Flushing holes		Buttons (mm)		Catalogue no.
mm	inch	Side No x Size	Front No x Size	Gauge No x Size	Front No x Size	
80	3 5/32	-	3x10	9x12	8x10	B53080T5105R
80	3 5/32	-	3x10	9x12	8x10	B53080T5105S
89	3 1/2	-	3x11	9x13	9x11	B53089T5105R
89	3 1/2	-	3x11	9x13	9x11	B53089T5105S
102	4	-	3x12	9x14	9x12	B53102T5105R
102	4	-	3x12	9x14	9x12	B53102T5105S
115	4 1/2	-	3x12	9x15	10x13	B53115T5105R
115	4 1/2	-	3x12	9x15	10x13	B53115T5105S
127	5	-	3x13	9x16	10x14	B53127T5105R
127	5	-	3x13	9x16	10x14	B53127T5105S
152	6	-	3x14	9x17	10x15	B53152T5105R
152	6	-	3x14	9x17	10x15	B53152T5105S

R – spherical (Gauge angle (35°))

S – ballistic (Gauge angle (40°))

Button bit – FLAT FACE – Heavy Duty

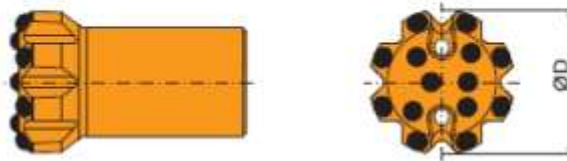

Diameter		Flushing holes		Buttons (mm)		Catalogue no.
mm	inch	Side No x Size	Front No x Size	Gauge No x Size	Front No x Size	
80	3 1/2	-	2x12	8x13	5x12	B52080T5115R
89	3 1/2	-	2x13	8x14	5x13	B52089T5115R
102	4	-	2x13	8x15	6x14	B52102T5115R
115	4 1/2	-	2x14	8x16	7x15	B52115T5115R
127	5	-	2x14	8x17	8x16	B52127T5115R

R – spherical (Gauge angle (35°))

Button bit - FLAT FACE - RETRAC - Heavy Duty



Diameter		Flushing holes		Buttons (mm)		Catalogue no.
mm	inch	Side No x Size	Front No x Size	Gauge No x Size	Front No x Size	
80	3 1/2	-	2x12	8x13	5x12	B53080T5115R
89	3 1/2	-	2x13	8x14	5x13	B53089T5115R
102	4	-	2x13	8x15	6x14	B53102T5115R
115	4 1/2	-	2x14	8x16	7x15	B53115T5115R
127	5	-	2x14	8x17	8x16	B53127T5115R

R - spherical (Gauge angle (35°))

Button bit



Diameter		Flushing holes		Buttons (mm)		Catalogue no.
mm	inch	Side No x Size	Front No x Size	Gauge No x Size	Front No x Size	
89	3 1/2	-	2x12	8x13	6x13	B54089T5105R
102	4	-	2x13	8x13	7x13	B54102T5105R
115	4 1/2	-	2x13	8x14	8x13	B54115T5105R
127	5	-	2x14	8x15	4x15, 4x13	B54127T5105R

R - spherical (Front angle (20°), Gauge angle (40°))

Reaming button bit



Diameter		Flushing holes		Buttons (mm)		Catalogue no.
mm	inch	Side No x Size	Front No x Size	Gauge No x Size	Front No x Size	
115	4 ½	1x9	3x9	9x13	5x13, 3x12	B54115T5115R
127	5	1x10	3x10	9x14	5x14, 4x13	B54127T5115R
152	6	1x11	3x11	9x15	11x15	B54152T5115R

R – spherical (Gauge angle (35°))

Cross bit - RETRAC



Diameter		Flushing holes		Buttons (mm)		Catalogue no.
mm	inch	Side No x Size	Front No x Size	Gauge No x Size	Front No x Size	
102	4	-	1x16	-	3x13	B47102T511B2
115	4 ½	-	1x16	-	3x13	B47115T511B2
127	5	-	1x16	-	3x14	B47127T511B2
140	5 ½	-	1x16	-	3x14	B47140T511B2
152	6	-	1x16	-	3x14	B47152T511B2

Extension rods

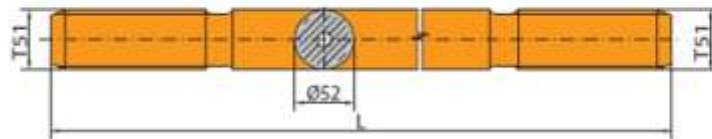

Diameter		Threads	Length			Catalogue no.
mm	inch		mm	ft	inch	
52	2	T51/T51	915	3	-	2805009
52	2	T51/T51	1220	4	-	28050122
52	2	T51/T51	1525	5	-	28050152
52	2	T51/T51	1830	6	-	28050183
52	2	T51/T51	2165	7	-	28050216
52	2	T51/T51	2435	8	-	28050243
52	2	T51/T51	3050	10	-	2805030
52	2	T51/T51	3660	12	-	2805036
52	2	T51/T51	4265	14	-	28050427
52	2	T51/T51	4915	16	-	28050491
52	2	T51/T51	6100	20	-	28050610
52	2	T51/T51	7200	24	-	28050720

Flushing hole ϕ 21,5 mm

Speed rods / M-F rods

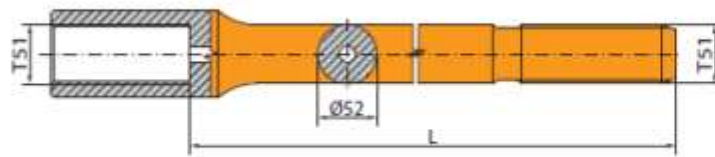

Diameter		Threads	Length			Catalogue no.
mm	inch		mm	ft	inch	
52	2	T51/T51	1525	5	-	26929152
52	2	T51/T51	1830	6	-	26929183
52	2	T51/T51	2165	7	-	26929216
52	2	T51/T51	2435	8	-	26929243
52	2	T51/T51	3050	10	-	26929305
52	2	T51/T51	3660	12	-	26929366
52	2	T51/T51	4265	14	-	26929427
52	2	T51/T51	4915	16	-	26929491
52	2	T51/T51	6100	20	-	26929610
52	2	T51/T51	7200	24	-	26929720

Flushing hole ϕ 21,5 mm, Female end ϕ 74 mm

Guide tube rods

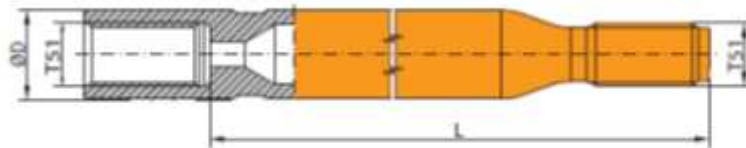

Diameter		Threads	Length			Catalogue no.
mm	inch		mm	ft	inch	
76	3	T51/T51	1830	6	-	1276T51T51183
76	3	T51/T51	3660	12	-	1276T51T51366
76	3	T51/T51	4265	14	-	1276T51T51426
87	3 ½	T51/T51	3660	12	-	1287T51T51366
87	3 ½	T51/T51	4265	14	-	1287T51T51426

Guide tube rods

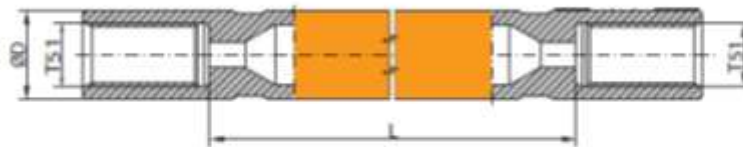

Diameter		Threads	Length			Catalogue no.
mm	inch		mm	ft	inch	
76	3	T51/T51	1830	6	-	1376T51T51183
76	3	T51/T51	3660	12	-	1376T51T51366
76	3	T51/T51	4265	14	-	1376T51T51426
87	3 ½	T51/T51	3660	12	-	1387T51T51366
87	3 ½	T51/T51	4265	14	-	1387T51T51426

Coupling sleeve

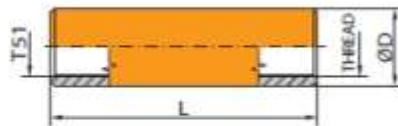

Diameter		Threads	Length		Catalogue no.
mm	inch		mm	inch	
72	2 ¾	T51/T51	210	8 ½	3952532
74	3	T51/T45	195	7 ¾	3952300
74	3	T51/T51	210	8 ½	3952500

Full bridge

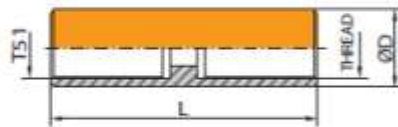

Diameter		Threads	Length		Catalogue no.
mm	inch		mm	inch	
76	3	T51/T45	225	8 ¾	3952301
76	3	T51/T51	240	9 ½	3952501

M-F adapters

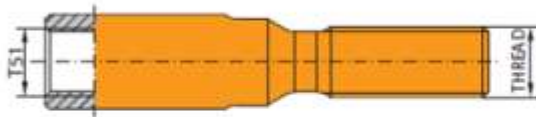

Threads female/male	Length		Catalogue no.
	mm	inch	
T51/T45	300	11 3/4	3952306
T51/GT60	300	11 3/4	3954606

M-M adapters



Threads male/male	Length		Catalogue no.
	mm	inch	
T51/T51	250	9 3/4	3851T51T5100

Button bit – DROP CENTER



Diameter		Flushing holes		Buttons (mm)		Catalogue no.
mm	inch	Side No x Size	Front No x Size	Gauge No x Size	Front No x Size	
92	3 1/2	-	4x11	8x14	5x13	B50092G6005R
92	3 1/2	-	4x11	8x14	5x13	B50092G6005S
96	3 3/4	-	4x11	8x14	6x13	B50096G6005R
96	3 3/4	-	4x11	8x14	6x13	B50096G6005S
102	4	-	4x12	8x14	6x13	B50102G6005R
102	4	-	4x12	8x14	6x13	B50102G6005S
115	4 1/2	-	4x12	8x15	6x14	B50115G6005R
115	4 1/2	-	4x12	8x15	6x14	B50115G6005S
127	5	-	4x13	8x16	8x15	B50127G6005R
127	5	-	4x13	8x16	8x15	B50127G6005S
140	5 1/2	-	4x13	8x17	4x15, 4x16	B50140G6005R
140	5 1/2	-	4x13	8x17	4x15, 4x16	B50140G6005S

R – spherical (Gauge angle (35°))

S – ballistic (Gauge angle (40°))

Button bit – DROP CENTER – RETRAC

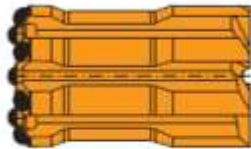

Diameter		Flushing holes		Buttons (mm)		Catalogue no.
mm	inch	Side No x Size	Front No x Size	Gauge No x Size	Front No x Size	
92	3 5/8	-	4x11	8x14	5x13	B51092G6005R
92	3 5/8	-	4x11	8x14	5x13	B51092G6005S
96	3 7/8	-	4x11	8x14	6x13	B51096G6005R
96	3 7/8	-	4x11	8x14	6x13	B51096G6005S
102	4	-	4x12	8x14	6x13	B51102G6005R
102	4	-	4x12	8x14	6x13	B51102G6005S
115	4 1/2	-	4x12	8x15	6x14	B51115G6005R
115	4 1/2	-	4x12	8x15	6x14	B51115G6005S
127	5	-	4x13	8x16	8x15	B51127G6005R
127	5	-	4x13	8x16	8x15	B51127G6005S
140	5 1/2	-	4x13	8x17	4x15, 4x16	B51140G6005R
140	5 1/2	-	4x13	8x17	4x15, 4x16	B51140G6005S

R – spherical (Gauge angle (35°))

S – ballistic (Gauge angle (40°))

Button bit – FLAT FACE

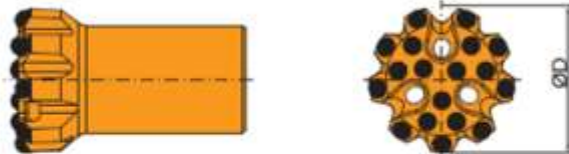

Diameter		Flushing holes		Buttons (mm)		Catalogue no.
mm	inch	Side No x Size	Front No x Size	Gauge No x Size	Front No x Size	
102	4	-	3x14	9x14	9x12	B52102G6005R
102	4	-	3x14	9x14	9x12	B52102G6005S
115	4 ½	-	3x14	9x15	10x13	B52115G6005R
115	4 ½	-	3x14	9x15	10x13	B52115G6005S
127	5	-	3x14	9x16	10x14	B52127G6005R
127	5	-	3x14	9x16	10x14	B52127G6005S
140	5 ½	-	3x14	9x17	10x15	B52140G6005R
140	5 ½	-	3x14	9x17	10x15	B52140G6005S
152	6	-	3x14	9x17	10x15	B52152G6005R
152	6	-	3x14	9x17	10x15	B52152G6005S

R – spherical (Gauge angle (35°))

S – ballistic (Gauge angle (40°))

Button bit – FLAT FACE – RETRAC



Diameter		Flushing holes		Buttons (mm)		Catalogue no.
mm	inch	Side No x Size	Front No x Size	Gauge No x Size	Front No x Size	
102	4	-	3x14	9x14	9x12	B53102G6005R
102	4	-	3x14	9x14	9x12	B53102G6005S
115	4 ½	-	3x14	9x15	10x13	B53115G6005R
115	4 ½	-	3x14	9x15	10x13	B53115G6005S
127	5	-	3x14	9x16	10x14	B53127G6005R
127	5	-	3x14	9x16	10x14	B53127G6005S
140	5 ½	-	3x14	9x17	10x15	B53140G6005R
140	5 ½	-	3x14	9x17	10x15	B53140G6005S
152	6	-	3x14	9x17	10x15	B53152G6005R
152	6	-	3x14	9x17	10x15	B53152G6005S

R – spherical (Gauge angle (35°))

S – ballistic (Gauge angle (40°))

Extension rods

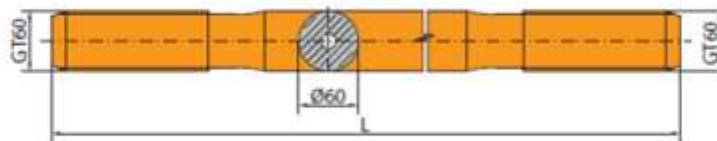

Diameter		Threads	Length			Catalogue no.
mm	inch		mm	ft	inch	
60	2 3/8	GT60/GT60	1830	6	-	10R60G60G60183
60	2 3/8	GT60/GT60	2165	7	-	10R60G60G60216
60	2 3/8	GT60/GT60	2435	8	-	10R60G60G60243
60	2 3/8	GT60/GT60	3050	10	-	10R60G60G60305
60	2 3/8	GT60/GT60	3660	12	-	10R60G60G60366
60	2 3/8	GT60/GT60	4265	14	-	10R60G60G60426
60	2 3/8	GT60/GT60	4915	16	-	10R60G60G60491
60	2 3/8	GT60/GT60	5470	18	-	10R60G60G60547
60	2 3/8	GT60/GT60	6100	20	-	10R60G60G60610

Flushing hole ϕ 22,6 mm

Speed rods / M-F rods

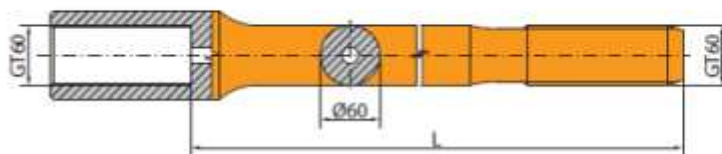

Diameter		Threads	Length			Catalogue no.
mm	inch		mm	ft	inch	
60	2 3/8	GT60/GT60	1830	6	-	11R60G60G60183
60	2 3/8	GT60/GT60	2165	7	-	11R60G60G60216
60	2 3/8	GT60/GT60	2435	8	-	11R60G60G60243
60	2 3/8	GT60/GT60	3050	10	-	11R60G60G60305
60	2 3/8	GT60/GT60	3660	12	-	11R60G60G60366
60	2 3/8	GT60/GT60	4265	14	-	11R60G60G60426
60	2 3/8	GT60/GT60	4915	16	-	11R60G60G60491
60	2 3/8	GT60/GT60	5470	18	-	11R60G60G60547
60	2 3/8	GT60/GT60	6100	20	-	11R60G60G60610

Flushing hole ϕ 22,6 mm, Female end ϕ 85 mm

Drill tube rods

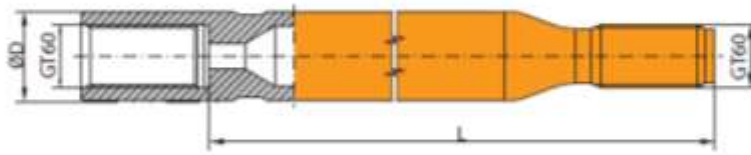

Diameter		Threads	Length			Catalogue no.
mm	inch		mm	ft	inch	
87	3 1/2	GT60/GT60	3660	12	-	1287G60G60366
87	3 1/2	GT60/GT60	4265	14	-	1287G60G60426

Drill tube rods

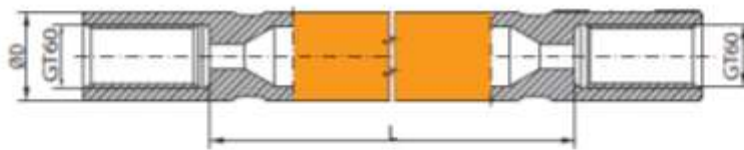

Diameter		Threads	Length			Catalogue no.
mm	inch		mm	ft	inch	
87	3 1/2	GT60/GT60	3660	12	-	1387G60G60366
87	3 1/2	GT60/GT60	4265	14	-	1387G60G60426

Coupling sleeve

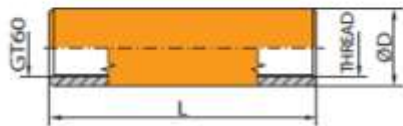

Diameter		Threads	Length		Catalogue no.
mm	inch		mm	inch	
85	3 ¼	GT60/T51	285	11 ¼	3985G60T5100
85	3 ¼	GT60/GT60	320	12 ¼	3985G60G6000

M-F adapters

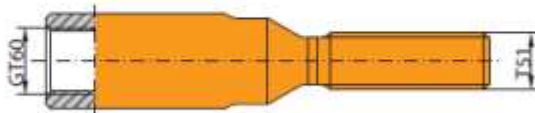

Threads	Length		Catalogue no.
	mm	inch	
female/male	300	11 ¼	3985G60T5103

M-M adapters



Threads	Length		Catalogue no
	mm	inch	
male/male	340	13 ¼	3860G60G6000

Shank adapter 1

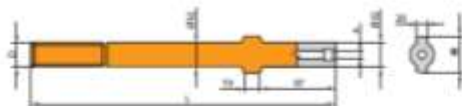

Thread	Diameter (mm)	Length (mm)	Flushing hole (mm)	Weight (kg)	Catalogue no.
R32	32	300	10	2.1	3514382
Y38	32	300	10	2.3	35163821

Drill rig producer	Drill type
Atlas Copco	BBC 41 / BBC 43 / BBC 44 / BBC 45 / BBC 100
Böhler	HM 600 D
Gardner Denver	79 / 93 / 99
Ingersoll Rand	DA 35 / DA 505
Joy	TM 400
Le Roy	D 14 DR / D 25 DR
Montabert	LC 50 / TA 35
Tamrock	S 125

Shank adapter 2



Thread	Diameter (mm)	Length (mm)	Flushing hole (mm)	Weight (kg)	Catalogue no.
R32	32	300	10	2.0	3514384

Drill rig producer	Drill type
Ingersoll Rand	HBM 50
Tamrock	HL 432 / L 400 / L 500

Shank adapter 3

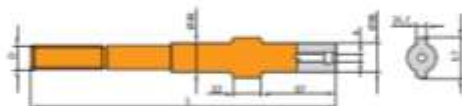

Thread	Diameter (mm)	Length (mm)	Flushing hole (mm)	Weight (kg)	Catalogue no.
R28	38	300	10	2.6	3513380
R32	38	300	10	2.7	3514380
R38	38	300	10	3.1	3515382
Y38	38	300	10	2.3	3516382

Drill rig producer	Drill type
Atlas Copco	BBC 51 / BBC 52 / BBC 54 / BBC 120 / BBS 54 / BBS 120
Böhler	HM 755 D
Montabert	H40 / H50 / H60 / H70

Shank adapter 4

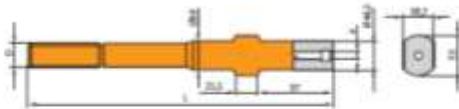

Thread	Diameter (mm)	Length (mm)	Flushing hole (mm)	Weight (kg)	Catalogue no.
R32	38	330	12	2,4	3614332
R32	38	330	14	2,4	3714332
R38	38	330	12	2,6	3615332
R38	38	330	14	2,6	3715332
T38	38	330	14	2,6	3716332

Drill rig producer	Drill type
Demag	RD 400
Furukawa	795 D
Gardner Denver	DH 99 / DH 123
Ingersoll Rand	DA 45 / DA 475

Shank adapter 5

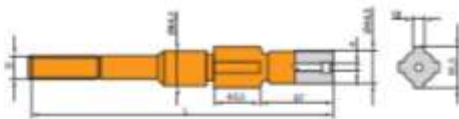

Thread	Diameter (mm)	Length (mm)	Flushing hole (mm)	Weight (kg)	Catalogue no.
R32	44,3	380	14	3,0	3714381
R32	44,3	380	14	3,6	3714381
R38	44,3	380	14	3,8	3615381
R38	44,3	380	12	3,8	3715381
T38	44,3	380	14	3,8	3716381
T45	44,3	380	14	3,8	3718381

Drill rig producer	Drill type
Demag	RD 500
Furukawa	M 120 / PD 200
Gardner Denver	PR 123
Tamrock	L 600 / L 750

Shank adapter 6

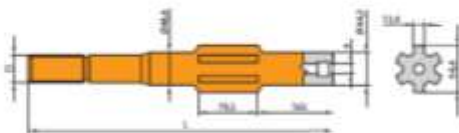

Thread	Diameter (mm)	Length (mm)	Flushing hole (mm)	Weight (kg)	Catalogue no.
R38	44,4	440	14	4,0	3715446
T38	44,4	440	14	4,0	3716446
T38	44,4	540	12	5,3	3816906

Drill rig producer	Drill type
Atlas Copco	BBE 56 U2 / BBE 57 / BBE 5701
Furukawa	HCR 300 S
Ingersoll Rand	LM 400

Atlas Copco COP 125 / COP 130 / COP 131

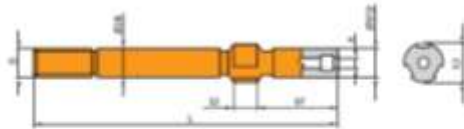

Thread	Diameter (mm)	Length (mm)	Flushing hole (mm)	Weight (kg)	Catalogue no.
R32	38	415	14	2.7	3714413
R38	38	380	14	2.9	3715383
T38	38	380	14	2.9	3716383
T45	38	380	14	3.0	3718383

Atlas Copco COP 1028

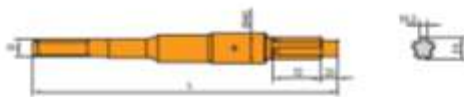

Thread	Diameter (mm)	Length (mm)	Flushing hole (mm)	Weight (kg)	Catalogue no.
R25	45	400	-	2.6	3412405
R28	45	400	-	2.7	3413405
R32	45	400	-	2.8	3414405

Atlas Copco COP 1028 HD

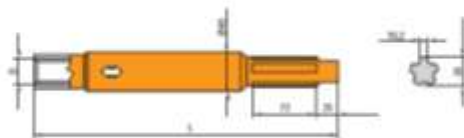

Thread	Diameter (mm)	Length (mm)	Flushing hole (mm)	Weight (kg)	Catalogue no.
R28	45	245	-	1.7	3423245

Atlas Copco COP 1036 / COP 1038 HB / COP 1038 HD / COP 1238 HF / COP 1238 LE / COP 1238 ME

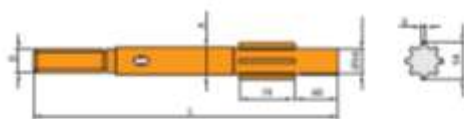

Thread	Diameter (mm)	Length (mm)	Flushing hole (mm)	Weight (kg)	Catalogue no.
R25	38	485	-	3.8	3412488
R32	38	485	-	4.0	3414488
R32	38	500	-	4.1	3414508
R32	38	575	-	4.7	3414578
R38	38	462	-	3.9	3415468
R38	38	485	-	4.1	3415488
R38	38	500	-	4.2	3415508
T38	38	485	-	4.1	3416488
T38	38	500	-	4.2	3416508
T38	38	590	-	4.9	3416598
T45	45	500	-	5.4	3418508
T45	45	575	-	6.0	3418578

Atlas Copco COP 1038 HL / COP 1238

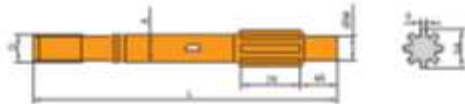

Thread	Diameter (mm)	Length (mm)	Flushing hole (mm)	Weight (kg)	Catalogue no.
R32	38	575	-	4.7	34145781
T38	38	575	-	4.8	34165781
T45	45	575	-	6.0	34185781

Atlas Copco COP 1132

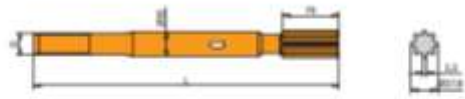

Thread	Diameter (mm)	Length (mm)	Flushing hole (mm)	Weight (kg)	Catalogue no.
R28	35	410	-	2.4	3413418
R32	35	410	-	2.5	3414418

Atlas Copco COP 1238

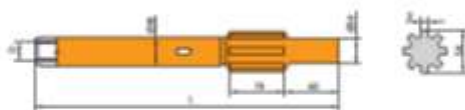

Thread	Diameter (mm)	Length (mm)	Flushing hole (mm)	Weight (kg)	Catalogue no.
R25	38	485	-	3.8	3422488
R32	38	485	-	4.0	3424488
R38	38	485	-	4.2	3425488
T38	38	485	-	4.2	3426488

Atlas Copco COP 1432 F

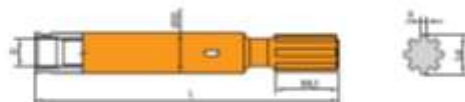

Thread	Diameter (mm)	Length (mm)	Flushing hole (mm)	Weight (kg)	Catalogue no.
R32	55	341	-	4.2	3424348
R38	55	341	-	4.4	3425348
T38	55	341	-	4.4	3426348

Atlas Copco COP 1432 / COP 1440 / COP 1532 / COP 1838 HD

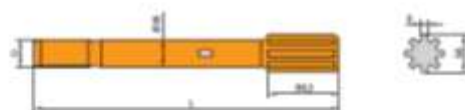

Thread	Diameter (mm)	Length (mm)	Flushing hole (mm)	Weight (kg)	Catalogue no.
R32	38	435	-	4.0	3414438
R32	38	525	-	4.0	3414528
R38	38	435	-	4.0	3415438
R38	38	455	-	4.1	34154582
R38	38	525	-	4.7	34155281
T38	38	435	-	4.0	3416438
T38	38	525	-	5.7	34165283

Atlas Copco COP 1440 / COP 1550 / COP 1838

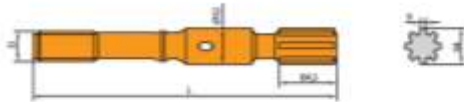

Thread	Diameter (mm)	Length (mm)	Flushing hole (mm)	Weight (kg)	Catalogue no.
R32	52	525	-	3,8	34145284
R38	52	525	-	6,0	34155283
T38	52	525	-	6,0	34165282
T45	52	525	-	6,7	34185281
T51	52	525	-	6,8	3410528

Atlas Copco COP 1440 / COP 1838

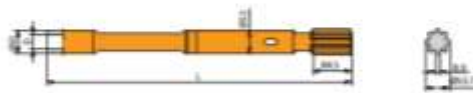

Thread	Diameter (mm)	Length (mm)	Flushing hole (mm)	Weight (kg)	Catalogue no.
R32	52	640	-	7,5	3424648
R38	52	650	-	7,9	3425658

Atlas Copco COP 1640 / COP 1840

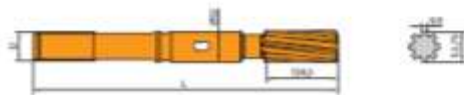

Thread	Diameter (mm)	Length (mm)	Flushing hole (mm)	Weight (kg)	Catalogue no.
T38	52	565	-	7,0	3416568
T45	52	565	-	7,2	3418568
T51	52	565	-	7,6	3410568

Atlas Copco COP 1840 Extractor

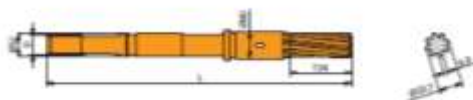

Thread	Diameter (mm)	Length (mm)	Flushing hole (mm)	Weight (kg)	Catalogue no.
T45	60	770	-	11,4	34187782
T51	60	770	-	12,2	34107782

Atlas Copco COP 2160

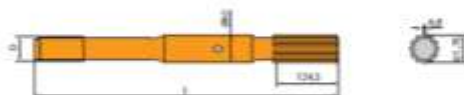

Thread	Diameter (mm)	Length (mm)	Flushing hole (mm)	Weight (kg)	Catalogue no.
T45	60	770	-	10,9	34187712
T51	60	770	-	11	34107711

Atlas Copco COP 2160 Extractor

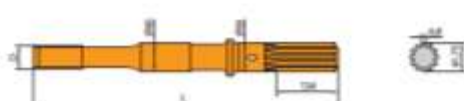

Thread	Diameter (mm)	Length (mm)	Flushing hole (mm)	Weight (kg)	Catalogue no.
T45	63	770	-	13,2	3418779
T51	63	770	-	13,3	3410779

Atlas Copco COP 2560

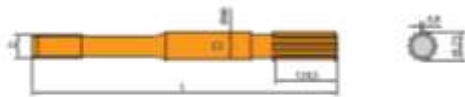

Thread	Diameter (mm)	Length (mm)	Flushing hole (mm)	Weight (kg)	Catalogue no.
T51	60	770	-	11,0	34107711
T60	60	770	-	12,4	34127711

Atlas Copco COP 2560 Extractor

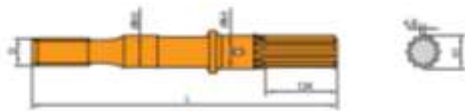

Thread	Diameter (mm)	Length (mm)	Flushing hole (mm)	Weight (kg)	Catalogue no.
T51	63	770	-	13,3	3410771
T60	63	770	-	14,0	3412771
GT60	63	770	-	14,0	34127712

Atlas Copco COP 3038

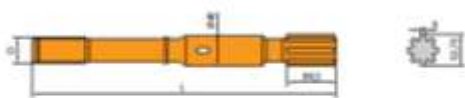

Thread	Diameter (mm)	Length (mm)	Flushing hole (mm)	Weight (kg)	Catalogue no.
T38	45	435	-	4,8	34164382
T38	45	525	-	5,2	34165284

Atlas Copco COP 4050(L)

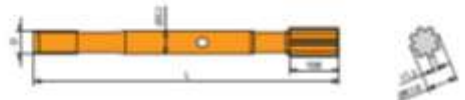

Thread	Diameter (mm)	Length (mm)	Flushing hole (mm)	Weight (kg)	Catalogue no.
T51	52	605	-	9,1	34106180

Atlas Copco COP 4050 Extractor

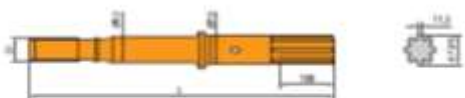

Thread	Diameter (mm)	Length (mm)	Flushing hole (mm)	Weight (kg)	Catalogue no.
T51	70	790	-	14,7	34107981

Atlas Copco COP 4050 Extractor

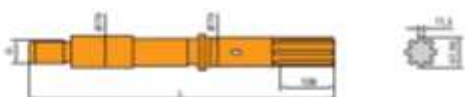

Thread	Diameter (mm)	Length (mm)	Flushing hole (mm)	Weight (kg)	Catalogue no.
ST58	70	790	-	21,8	3411838

Atlas Copco COP 4050 Extractor

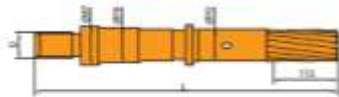

Thread	Diameter (mm)	Length (mm)	Flushing hole (mm)	Weight (kg)	Catalogue no.
ST68	70	835	-	21.7	3413839

Boart HD 65

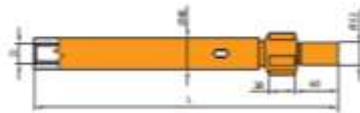

Thread	Diameter (mm)	Length (mm)	Flushing hole (mm)	Weight (kg)	Catalogue no.
R25	45	325	-	3,6	3423325
R28	45	325	-	3,5	3423325
R32	45	325	-	3,5	3423325

Boart HD 125 / HD 150

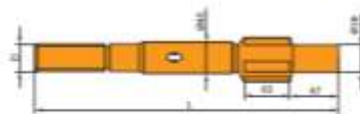

Thread	Diameter (mm)	Length (mm)	Flushing hole (mm)	Weight (kg)	Catalogue no.
R32	45	495	-	5,2	3414495
R32	45	545	-	5,9	3414545
R32	45	572	-	6,0	3414575
R38	45	495	-	5,7	3415495
T38	45	495	-	5,5	3416495
T38	45	590	-	6,3	3416595
T38	45	570	-	6,2	3416575

Boart HD 125 / HD 150

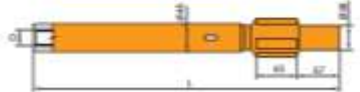

Thread	Diameter (mm)	Length (mm)	Flushing hole (mm)	Weight (kg)	Catalogue no.
R25	45	495	-	6,1	3422495
R25	45	572	-	7,0	3422575
R32	45	343	-	4,2	3423345

Boart HD 155

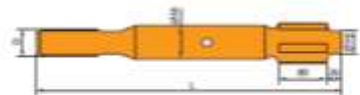

Thread	Diameter (mm)	Length (mm)	Flushing hole (mm)	Weight (kg)	Catalogue no.
R32	55	578	-	8,4	3414575
R38	55	578	-	9,5	3415585
T45	55	578	-	9,6	3418585
T54	55	578	-	9,7	3418575

Boart HD 155

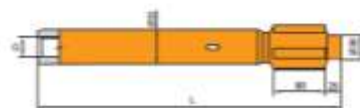

Thread	Diameter (mm)	Length (mm)	Flushing hole (mm)	Weight (kg)	Catalogue no.
R32	55	578	-	9,7	3424585
R38	55	578	-	9,4	3425585

Emmanchements

Furukawa / Gardner Denver / Ingersoll Rand

Furukawa HCR 9-DS / HD 609

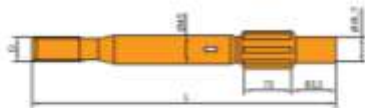

Thread	Diameter (mm)	Length (mm)	Flushing hole (mm)	Weight (kg)	Catalogue no.
T51	45	690	-	6,4	3416698

Furukawa HD 715

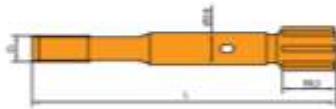

Thread	Diameter (mm)	Length (mm)	Flushing hole (mm)	Weight (kg)	Catalogue no.
T51	58	790	-	6,4	3410798

Furukawa HD 715 RP

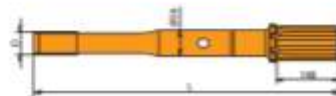

Thread	Diameter (mm)	Length (mm)	Flushing hole (mm)	Weight (kg)	Catalogue no.
T51	58	885	-	16,0	3410888

Gardner Denver HPR 2

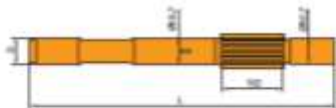

Thread	Diameter (mm)	Length (mm)	Flushing hole (mm)	Weight (kg)	Catalogue no.
T51	50,7	914	-	14,0	3410919

Ingersoll Rand YH 65 / YH 70

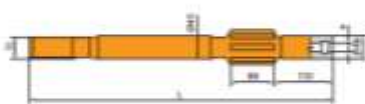

Thread	Diameter (mm)	Length (mm)	Flushing hole (mm)	Weight (kg)	Catalogue no.
T38	45	500	19	5,2	3816506
T45	45	500	19	5,5	3818506

Ingersoll Rand YH 65 RP

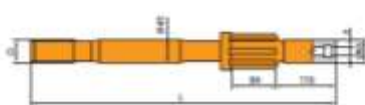

Thread	Diameter (mm)	Length (mm)	Flushing hole (mm)	Weight (kg)	Catalogue no.
T38	45	700	19	7,8	3816706
T45	45	700	19	7,9	3818706

Emmanchements

Ingersoll Rand / Joy

Ingersoll Rand YH 80 A

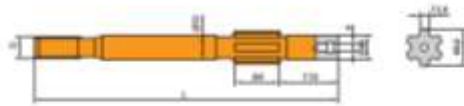

Thread	Diameter (mm)	Length (mm)	Flushing hole (mm)	Weight (kg)	Catalogue no.
T38	51	500	19	5,5	3816046
T45	51	500	19	5,7	3818036
T51	51	500	19	6,4	3810026

Ingersoll Rand YH 80 A RP

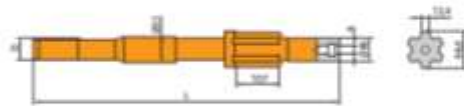

Thread	Diameter (mm)	Length (mm)	Flushing hole (mm)	Weight (kg)	Catalogue no.
T45	51	700	19	8,8	38187061
T51	51	700	19	9,3	38107061

Ingersoll Rand YH 95 / YH 100

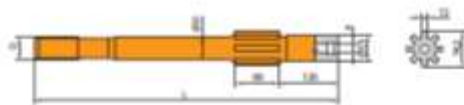

Thread	Diameter (mm)	Length (mm)	Flushing hole (mm)	Weight (kg)	Catalogue no.
T51	51	625	23	8,2	3810028

Ingersoll Rand YH 95 RP / YH 100 RP

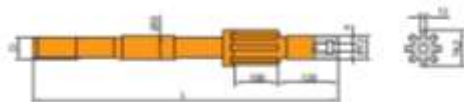

Thread	Diameter (mm)	Length (mm)	Flushing hole (mm)	Weight (kg)	Catalogue no.
T51	51	840	23	11,6	3810848

Ingersoll Rand YH 110 V / YH 135

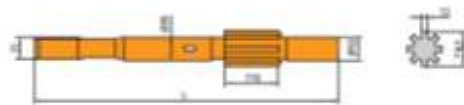

Thread	Diameter (mm)	Length (mm)	Flushing hole (mm)	Weight (kg)	Catalogue no.
T45	55	728	-	11,4	3418728
T51	55	728	-	11,7	3410728

Joy VCR 360

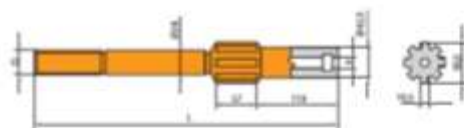

Thread	Diameter (mm)	Length (mm)	Flushing hole (mm)	Weight (kg)	Catalogue no.
T38	38	387	16	3,9	3816018

Emmanchements

Krupp / Montabert

Krupp HB 101

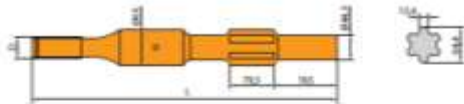

Thread	Diameter (mm)	Length (mm)	Flushing hole (mm)	Weight (kg)	Catalogue no.
T38	65	650	-	10,9	3416656

Krupp HB 101

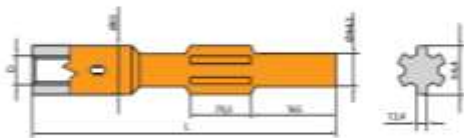

Thread	Diameter (mm)	Length (mm)	Flushing hole (mm)	Weight (kg)	Catalogue no.
R38	65	590	-	10,7	3425596
T38	65	590	-	10,7	3426596
T45	65	590	-	10,5	3428596

Montabert HC 40 / HC 50

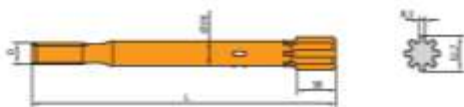

Thread	Diameter (mm)	Length (mm)	Flushing hole (mm)	Weight (kg)	Catalogue no.
R32	38	370	-	3,0	3414378
R32	38	445	-	3,5	3414481
R38	38	370	-	3,3	3415378
R38	38	380	-	3,2	34153881
R38	38	445	-	4,0	3415481
T38	38	370	-	3,2	3416378
T38	38	445	-	3,8	3416448

Montabert HC 80 / HC 90 / HC 105

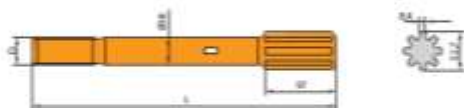

Thread	Diameter (mm)	Length (mm)	Flushing hole (mm)	Weight (kg)	Catalogue no.
R32	38	440	-	3,6	3414448
R38	38	440	-	3,9	3415448
T38	38	440	-	3,9	34164481

Montabert HC 80 RP / HC 120 RP

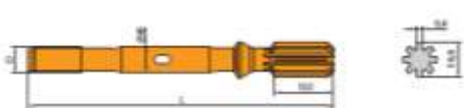

Thread	Diameter (mm)	Length (mm)	Flushing hole (mm)	Weight (kg)	Catalogue no.
T38	45	770	-	8,6	3416778
T45	45	670	-	7,5	3418678
T45	45	770	-	8,6	3418778

Montabert HC 109

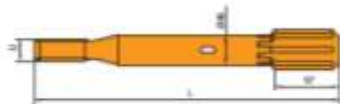

Thread	Diameter (mm)	Length (mm)	Flushing hole (mm)	Weight (kg)	Catalogue no.
R32	45	530	-	5,6	3414538
R38	45	530	-	5,9	3415338
T38	45	530	-	5,9	3416538
T45	45	530	-	6,1	3418538

Montabert HC 109



Thread	Diameter (mm)	Length (mm)	Flushing hole (mm)	Weight (kg)	Catalogue no.
R25	45	530	-	6,3	3422538

Montabert HC 120 RP / HC 150 RP / HC 155 RP / HC 158 RP

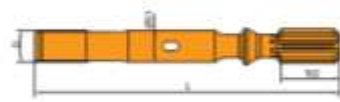

Thread	Diameter (mm)	Length (mm)	Flushing hole (mm)	Weight (kg)	Catalogue no.
T45	51	670	-	8,8	34186781
T45	51	770	-	10,2	34187781
T51	51	670	-	8,9	34106781

Montabert HC 160

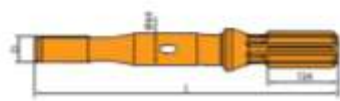

Thread	Diameter (mm)	Length (mm)	Flushing hole (mm)	Weight (kg)	Catalogue no.
T51	60	810	-	15,6	3410818

Montabert HC 200

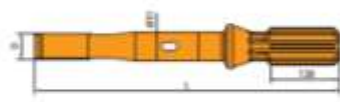

Thread	Diameter (mm)	Length (mm)	Flushing hole (mm)	Weight (kg)	Catalogue no.
T51	51	840	-	13,2	3410848

Montabert HC 200 A

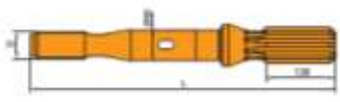

Thread	Diameter (mm)	Length (mm)	Flushing hole (mm)	Weight (kg)	Catalogue no.
T51	60	835	-	16,3	3410838
GT60	60	850	-	16,9	3412858

Emmanchements

Reedrill / Sandvik / Tamrock

Reedrill HPR 4519

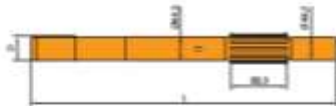

Thread	Diameter (mm)	Length (mm)	Flushing hole (mm)	Weight (kg)	Catalogue no.
T38	44,3	770	-	8,7	3416771
T45	44,5	770	-	9,0	3418771

Reedrill HPR 5123

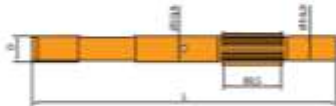

Thread	Diameter (mm)	Length (mm)	Flushing hole (mm)	Weight (kg)	Catalogue no.
T45	50,8	770	-	11,8	34187791
T51	50,8	770	-	12,1	34107791

Reedrill HPR 6030

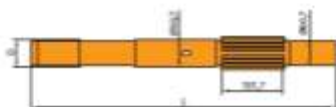

Thread	Diameter (mm)	Length (mm)	Flushing hole (mm)	Weight (kg)	Catalogue no.
T51	60,7	1041	-	19,5	3410109

Sandvik – Tamrock HL 300

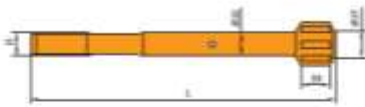

Thread	Diameter (mm)	Length (mm)	Flushing hole (mm)	Weight (kg)	Catalogue no.
R32	32	400	-	2,6	3414408

Sandvik – Tamrock HL 300 S

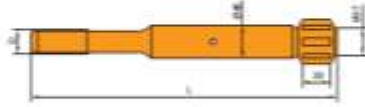

Thread	Diameter (mm)	Length (mm)	Flushing hole (mm)	Weight (kg)	Catalogue no.
R32	45	380	-	3,9	3414388
R38	45	580	-	4,1	3415388
T38	45	380	-	4,2	34163881

Sandvik – Tamrock HL 300 S

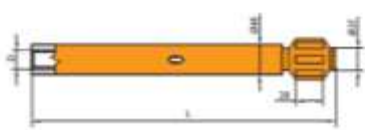

Thread	Diameter (mm)	Length (mm)	Flushing hole (mm)	Weight (kg)	Catalogue no.
R28	45	245	-	2,6	34232480
R32	45	245	-	2,6	34242480

Sandvik – Tamrock HL 438 L / HL 438 T / HLR 438 T

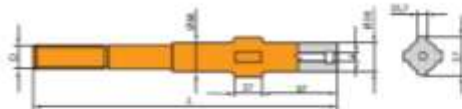

Thread	Diameter (mm)	Length (mm)	Flushing hole (mm)	Weight (kg)	Catalogue no.
R32	38	300	12	3,9	3614384
R38	38	300	12	3,9	3615384
T38	38	300	12	4,0	3616384

Sandvik – Tamrock HL 438 TS / HL 538

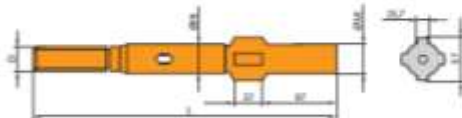

Thread	Diameter (mm)	Length (mm)	Flushing hole (mm)	Weight (kg)	Catalogue no.
R32	38	450	-	3,8	3414454
R38	38	450	-	4,4	3415454
R38	38	495	-	4,8	3415494
T38	38	450	-	4,4	3416454
T38	38	495	-	4,8	3416494
T38	38	545	-	5,2	3416544

Sandvik – Tamrock HL 500 / HL 500 S / HL 510 / HL 510 S

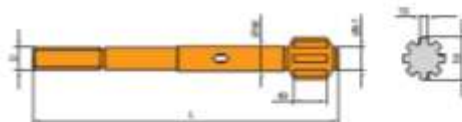

Thread	Diameter (mm)	Length (mm)	Flushing hole (mm)	Weight (kg)	Catalogue no.
R32	38	460	-	3,9	3414460
R32	38	550	-	4,3	3414580
R38	38	450	-	4,1	34154581
R38	38	460	-	4,2	34154681
R38	38	500	-	4,5	34155083
R38	38	550	-	4,6	3415558
T38	38	460	-	4,2	3416468
T38	38	500	-	4,5	34165082
T38	38	550	-	4,6	34165582

Sandvik – Tamrock HL 500 S

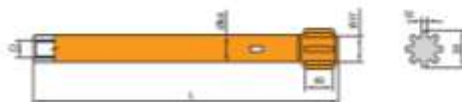

Thread	Diameter (mm)	Length (mm)	Flushing hole (mm)	Weight (kg)	Catalogue no.
R25	38	550	-	9,0	3422558

Sandvik – Tamrock HL 500 / HL 510

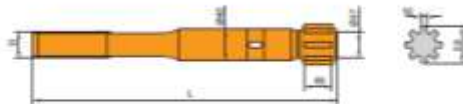

Thread	Diameter (mm)	Length (mm)	Flushing hole (mm)	Weight (kg)	Catalogue no.
R32	45	550	-	5,7	34145581
R38	45	500	-	5,4	34135084
T38	45	550	-	5,9	34165581
T45	45	550	-	6,2	3418558

Sandvik – Tamrock HL 600 / HL 600 S

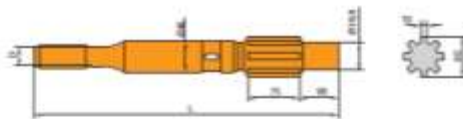

Thread	Diameter (mm)	Length (mm)	Flushing hole (mm)	Weight (kg)	Catalogue no.
R32	45	600	-	5,8	3414608
R38	45	525	-	5,6	3415528
T38	45	525	-	5,6	34165281
T38	45	600	-	6,0	3416608
T45	45	525	-	5,8	3418528
T45	45	600	-	6,4	3418608

Sandvik – Tamrock HL 645

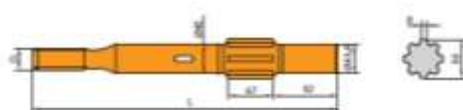

Thread	Diameter (mm)	Length (mm)	Flushing hole (mm)	Weight (kg)	Catalogue no.
R32	45	525	-	5,8	34145283
T38	45	600	-	6,3	34166083
T45	45	600	-	6,5	34186083

Sandvik – Tamrock HL 700 / HL 800

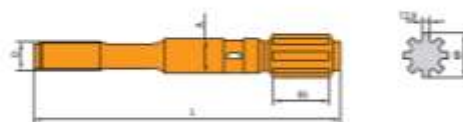

Thread	Diameter (mm)	Length (mm)	Flushing hole (mm)	Weight (kg)	Catalogue no.
T38	45	600	-	7,0	34166081
T45	45	600	-	7,2	34186081
T38	52	600	-	8,4	34166082
T45	52	600	-	8,8	34186082
T45	52	700	-	10,0	3418708
T51	52	600	-	9,2	3410608

Sandvik – Tamrock HL 1000

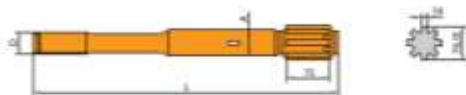

Thread	Diameter (mm)	Length (mm)	Flushing hole (mm)	Weight (kg)	Catalogue no.
T45	52	670	-	10,0	34186782
T51	52	590	-	9,3	34105980
T51	52	670	-	10,0	34106780
T60	60	670	-	12,7	34126781

Sandvik – Tamrock HL 1000

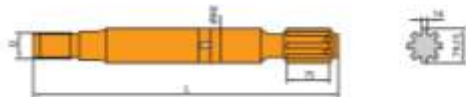

Thread	Diameter (mm)	Length (mm)	Flushing hole (mm)	Weight (kg)	Catalogue no.
ST58	80	635	-	18,4	3411638
ST68	80	640	-	18,8	3413648

Sandvik – Tamrock HL 1000

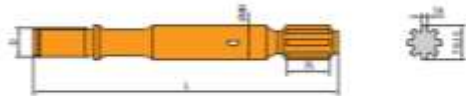

Thread	Diameter (mm)	Length (mm)	Flushing hole (mm)	Weight (kg)	Catalogue no.
GT60	80	670	-	19,5	34126782

Sandvik – Tamrock HL 1500

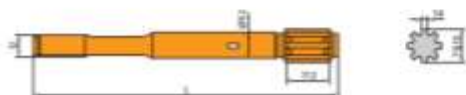

Thread	Diameter (mm)	Length (mm)	Flushing hole (mm)	Weight (kg)	Catalogue no.
T51	52	710	-	11,8	3410718

Sandvik – Tamrock HL 1500



Thread	Diameter (mm)	Length (mm)	Flushing hole (mm)	Weight (kg)	Catalogue no.
ST58	80	635	-	18,1	34116381
ST68	80	635	-	18,3	34136381

Sandvik – Tamrock HL 1500 / HL 1560

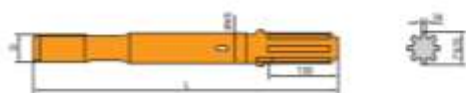

Thread	Diameter (mm)	Length (mm)	Flushing hole (mm)	Weight (kg)	Catalogue no.
T51	65	760	-	16,4	3410768
GT60	65	760	-	16,7	3412768

Sandvik – Tamrock HL 1500-80 / HL 1560-80



Thread	Diameter (mm)	Length (mm)	Flushing hole (mm)	Weight (kg)	Catalogue no.
GT60	80	760	-	21,5	34127681

Sandvik – Tamrock HLX 5

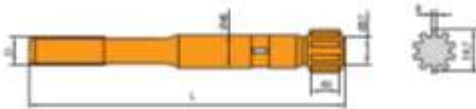

Thread	Diameter (mm)	Length (mm)	Flushing hole (mm)	Weight (kg)	Catalogue no.
R32	45	500	-	5,1	3414509
R38	45	500	-	5,4	3415509
T38	45	500	-	5,4	3416509
T45	45	575	-	6,4	3418579

Sandvik – Tamrock HLX 5 PE-45

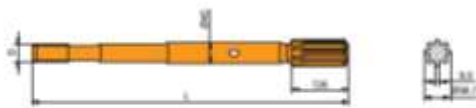

Thread	Diameter (mm)	Length (mm)	Flushing hole (mm)	Weight (kg)	Catalogue no.
R32	45	575	-	5,7	34145782
T38	45	720	-	7,6	34167281

Sandvik RD 520 / RD 525

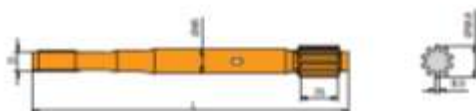

Thread	Diameter (mm)	Length (mm)	Flushing hole (mm)	Weight (kg)	Catalogue no.
T38	45	600	-	6,4	3416607

Secoma Hydrastar 200

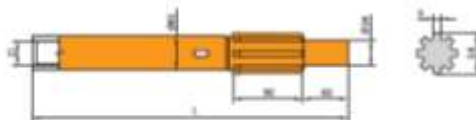

Thread	Diameter (mm)	Length (mm)	Flushing hole (mm)	Weight (kg)	Catalogue no.
R32	45	351	-	3,7	3424358

Soosan SP 3

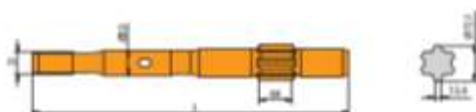

Thread	Diameter (mm)	Length (mm)	Flushing hole (mm)	Weight (kg)	Catalogue no.
T45	50	655	-	10,3	3418656

Emmanchements

Toyo

Toyo 650

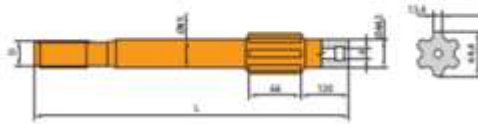

Thread	Diameter (mm)	Length (mm)	Flushing hole (mm)	Weight (kg)	Catalogue no.
T38	45	550	12	5,7	36165560

Outillage Fond de Trou

Nous vous proposons une gamme d'outils pour le forage fond de trou, incluant :

- ↻ **Marteaux de 1" à 12",**
- ↻ **Marteaux à circulation inverse 4" et 5",**
- ↻ **Marteaux excentriques,**
- ↻ **Taillants concaves, convexes, kavex ou plats,** pour la plupart des marteaux du marché,
- ↻ **Tubes de forage Ø 76 à 127 mm,** longueur 2 à 6 m,
- ↻ **Raccords MM, MF et FF.**



Nous consulter pour plus d'information.

Outillage CopRod

Nous vous proposons une gamme d'outils pour le forage CopRod, incluant :

- ↻ **Taillants COP76**
- ↻ **Taillants COP89**
- ↻ **Taillants COP102**
- ↻ **Taillants COP127**

Nous consulter pour plus d'information.



Fleurets mono-blocs et outils coniques

Nos fleurets mono-blocs sont disponibles avec les emmanchements suivant :

↳ HEX 19x108, HEX 22x108, HEX 25x108, HEX 25x159 et R32.



Nos outils coniques (tiges à emmanchement, allonges, manchons et taillants) sont disponibles en angles $4^{\circ}46'$, 7° et $7^{\circ}7'$.

Outillage Rotary

Nous vous proposons une gamme d'outils pour le rotary manuel (tiges rhombiques ou pas de vis, taillants 34 à 58 mm) et le rotary mécanisé (tiges hexagonales ou tubes, taillants 26 à 115 mm), ainsi que des taillants et tubes de carottages de 36 à 151 mm.

Nous consulter pour plus d'information.

Outils spéciaux

Notre partenaire fondeur peut également réaliser des outils et pièces spéciales sur mesure.

MCEP DISTRIBUTION vous propose également les outils, matériels et accessoires suivants :

- ↻ Matériel pour le minage,
- ↻ Graisse de forage,
- ↻ Ancrages auto-forants du R25 au T103,
- ↻ **Pièces d'usure pour godets et lames (dents, protections, etc.),**
- ↻ Pics pour tranchage, rabotage et fraisage,
- ↻ Outils pour puits et fondations spéciales,
- ↻ Foreuses hydrauliques et pneumatiques,
- ↻ Brise-roches hydrauliques et marteaux à mains,
- ↻ Pointes et accessoires,
- ↻ Nettoyeurs haute pression industriels,
- ↻ Produits anti-crevaison pour engins de chantier.

Pour plus d'information, contactez-nous :

commercial@mcep-distribution.com

eric.petit@mcep-distribution.com

admin@mcep-distribution.com

www.mcep-distribution.com

